

Battlebot

Senior Design

Miami University

ENT 497 and ENT 498

Braden Bakenhaster and Nicholas Newton

Advisor: Reza Abrisham Baf

5/3/2021

Statement of Purpose:

Battlebots are machines that have been popular to niche crowds over the past two decades. The show *Battlebots* first aired in the year 2000 and is still creating new episodes today. There are other similar robot fighting shows that have also been aired including *Robot Wars*, and battlebots have made other pop culture appearances such as in an episode of *The Big Bang Theory*. The battlebot arena has harbored many designs over the years. In our battlebot design, we have tried to draw from those designs to create our own bot that is designed to be effective, and affordable with reference to other bots in its class. We are going to construct a battlebot with a custom-built spinning weapon mechanism that will be able to compete at a high level against other battlebots within an acceptable budget. The battlebot will be built within the guidelines presented by the official Battlebot rules provided on the Battlebots website. The bot must be under 250 pounds, less than 8' x 8' in size, have the required safety on/off switches, and the power supply must be under 60 volts [4]. These rules set a standard to keep the contestants somewhat evenly matched, but do not impede on creativity.

Table of Contents

Statement of Purpose Pg. 2

Justification and Applicability Pg. 4

Design Pg. 4

Step-by-Step Pg. 9

Expected Findings Pg. 12

Conclusions and Future Works Pg. 25

References Pg. 27

Appendix Pg. 29

- Final Timeline Gantt Chart Pg. 29
- Cost Pg. 31
- Weight Analysis Pg. 33
- 3D Drawings and Diagrams Pg. 34
- Journals Pg. 45
- Proposal Pg. 56
- Final Presentation Slides Pg. 60

Justification and Applicability:

The justification for building this bot has a few parts. The first justification of building this bot is the design. The spinning weapon bots have had great success in the battlebots arena over the past few years. The next justification is the price. The design that we have developed is relatively low priced, \$2500, compared to other bots in the arena, and we believe that despite this lower price, it will still be effective [Appendix]. The last justification is the application of the project in terms of the ENT 497/498 class. This project meshes electrical and mechanical components very well. It presents a creative challenge to build due to its uniqueness.

Design:

The most important aspect of our design is the metal from which we will construct our battlebot. When looking at the design of other battlebots, the most commonly used metal for the professional arena is titanium, but aluminum is what your average daily battlebot hobbyist would build their bot from. Titanium is a very strong, durable, and light weight metal [1]. It is also a very expensive metal [2]. The amount we would have to spend on our battlebot would be unrealistic for our team members because we could not guarantee we would get enough funding to be able to build our robot out of titanium. Our next option was steel. Steel is durable and affordable; however, it would cause our robot to be over the 250-pound weight limit [3] set in place by the Battlebots Rules [4]. We spent some time looking over our design to see where we could cut-down our total weight. One way to reduce our weight would have been to drop the motor size, but then we would not have enough power to effectively run our battlebot. Our final option, and the metal we chose, was aluminum. Aluminum is light weight and affordable but is not known to be extremely durable. To combat this problem, we decided to add an extra layer of 1/8" aluminum diamond plate. The diamond plate will act as an outside layer of armor. The

diamond plate will not add enough weight for it to hinder the battlebots movement or cause it to be over the weight limit. We will mount the diamond plate by bolting it onto the outside frame. This will make it easily removable if it gets damaged. The total estimated weight of our battlebot is 158.5 pounds [Appendix].

Our motors are another big part of our battlebot. We need motors that are small but provide enough horsepower and torque to be able to maneuver our bot competitively within the arena. Once we began looking into the motors, we decided that 12-volt motors fit our criteria the best. We chose AmpFlo E30-150 motors for our left and right wheel motors. These have 0.7 peak horsepower [5] each and run 5900 RPM at a nominal voltage [5]. This will be plenty of power to maneuver our bot around the arena. These motors are going to come packaged together in an assembly that will have them attached to the wheels by a gear system. These wheel assemblies will be acquired from *Robot Market Place* and will be the high-speed ratio option. This higher speed ratio will allow our bot to move faster and dodge attacks from other bots. The next motor we need is for our spinner. We chose an AmpFlo E30-400 12V motor. It has a peak horsepower of 1.6 [5] and runs 6500 RPM at nominal voltage [5]. The higher horsepower will allow the spinner to rotate at a higher speed. We are going to connect the E30-400 AmpFlo motor to the spinner with sprockets and a chain. The chain will be 1/4" #25 chain. We will have one sprocket with an inside diameter of 1/2" for the spinner motor, and one sprocket with a 5/8" inside diameter to mount to the spinner. We originally used a 24V motor that had 3.6 horsepower chosen for the spinner application. We decided that it would be much simpler, and cheaper, to use an entirely 12V system in our design. This is because we wanted to run all of our motors off the same voltage supply which consists of three 12V 12Ah Mighty Max batteries.

The electrical design aspect of this battlebot was an important challenge. We tried to keep it simple, effective, and cost efficient. We also wanted to design it with accordance to the Battlebots Rules [4] [6]. The electrical components of this bot include two motor controllers, a remote controlled on/off switch, three Mighty Max 12V 12 Ah batteries, on/off switches, and a Turnigy transmitter with a 6 channel Turnigy receiver. The battlebot will use the three 12V 12Ah batteries in parallel so that the bot has the consistency and simplicity of a 12V system along with the higher amperage from the three batteries. In our initial design, we planned to use a 24V motor for the spinner, but this would have complicated the design, increased the cost, and another battery would have possibly been required. By our calculations, we estimate the current setup of the 12V system will run for roughly 40 minutes [7]. This is much more than the necessary run time for a battlebot because the Battlebots matches only last 3 minutes each [4]. The batteries also act as a counterweight to the heavy front spinner. The battlebot is designed to have two wheel-motors that power the movement of the bot and one that controls the bot's spinner. The wheel motors will be controlled by two Pololu Simple High-Power Motor Controllers. These controllers are able to handle the 12V and 36 Ah range [8] that we will be using in this bot. They will allow us to control the speed of each wheel with our Turnigy transmitter. These controllers are also programable. This allows us to be able to set the maximum speed, stop and start function, and forward to reverse function [8] giving us more control over the bot's movement. These controllers will connect to the receiver and the 12V batteries. One of the controllers will also power the receiver through its 5V BEC power connection. The BEC, battery elimination circuit, [9] is when the controller takes the full 12V that it is receiving from the battery to power the motor and steps it down to 5V to power smaller components like the receiver in this case. This is another reason that these controllers were

chosen because they eliminated the need for a 12V to 6V step-down to power the receiver. The battlebots spinner will be powered through a remote controlled on and off switch. This will allow us to turn the spinner on and off from the Turnigy transmitter. This switch will be connected to the receiver and the 12V batteries. We used this instead of another motor controller because the spinner speed does not need to speed up and slow down. It only needs a completely on and completely off setting because when it is on, it needs to be spinning as fast as possible to inflict damage on other bots. The battlebot design contains multiple manual on and off switches. This is because the battlebot rules requires multiple switches for safety reasons. It requires one for only the weapon, in this case the spinner, and for the entire bot [4]. We decided to err on the side of caution and use one for each wheel motor also. This will allow us to complete testing and function checks easier also. The last component is the Turnigy transmitter and receiver combo. While researching online what battlebots contestants commonly use in competitions, we discovered that while there is an array of options, many just use readily available hobby shop RC transmitters [10]. This is because they abide by the Battlebots Rules, and they are simple to setup in the arena. There is a limited time that contestants in Battlebots tournaments have to setup their controllers and limited room [4]. The transmitter we are using is a 2.4 GHz ISM frequency range and offers 20 channels [11]. It has a lcd display for programming to fit our needs. It is powered by four AA batteries. The receiver we are using is a six channel Turnigy receiver that comes with the transmitter. It will be powered by the motor controller as stated earlier.

Our battlebot is going to get hit, and we want to be able to withstand these hits. The shape of our bot has various angles, so it is not just a square box. The angles are meant to make it harder for an enemies' robot to get a direct hit on our bot. Not allowing other battlebots to have

a direct hit will allow for the battlebot to be able to get hit and not take as much damage. Limiting damage with single hits is important because of the aluminum makeup of our design. The bot has a tapered front end that will direct the other bots into the spinner. This is important as the spinner is the only weapon on the bot. We chose to put a spinner on the bot because of the success rate of other bots with similar weapons. The battlebots that move on to the final rounds almost always have a spinner of sort. We took some inspiration from the popular battlebot *Minotaur* [12]. This bot has a front spinner, and it has been very competitive in the arena for the past five years [12]. The shape of our spinner will be similar to an hourglass shape but will have sharper corners and will not be as rounded. It will be twelve inches long and three inches in diameter. Our spinner's cylinder will be made out of a steel with a higher carbon content, so we can harden it after shaping. Hardening the weapon will make it able to withstand intense impact on other hard metal surfaces. From the left side looking right, the spinner will be spinning clockwise. This will direct the impact forces down in the front keeping the bot from flipping. This will however cause the other bots to flip up into the air which could cause them to flip over making them immobile. Extra bracing will be added to front so our bot can handle front end ramming as well. The batteries will be housed at the back of the battlebot to counter for the heavy front spinner. They will be in a "box" made to act as bracing as well. This will stiffen the back of the bot up to help it absorb impacts.

Step by Step Plan:

- Research
 - Study rules for creating a battlebot
 - Define limitations and necessary components
 - Study what others have used in past competitions

- Create design
 - Create 3d model via Fusion 360
 - Create specs page for the design

- Create components list

- Create Ghant chart with timeline and tasks

- Create projected cost list

- Obtain proposal approval from ENT 497 professors

- Order frame components
 - Aluminum stock
 - Sheet Metal
 - Diamond Plate
 - Angle metal
 - Fasteners (bolts, nuts, washers, screws, etc.)

- Order motor and wheel components
 - Wheel and motor kits
 - Weapon motor

- Order spinner components
 - Steel stock
 - Pins
 - Sprockets
 - Mounts

- Build and shape bottom plate
 - Cut to desired shape from 2' x 2' x 0.25" Aluminum
 - Drill necessary bolt holes
 - Sand edges as needed

- Build side plates

- Cut to desired length from 6" x 18" x 0.25" Aluminum
 - Mount to bottom plate
 - Mount via welding and brackets
- Build Interior Bracing
 - To be built from 6" x 0.25" and 1" x 1" Aluminum
 - Cut to fit
 - Mounted to bottom plate and side walls
 - Mounted via welding and brackets
 - Battery box walls built
 - Mounted via welding and brackets
- Mount wheel assemblies
 - Mount to frame via bolts
 - Brackets maybe necessary
 - Mount rear caster wheel
- Spinner mounts
 - 0.25" Aluminum to be used to build up from bottom plate to desired height
 - Pillow block bearing, ball bearings 5/8" ID mounted on both sides of the front of the bot via bolts
- Construct spinner
 - Mill spinner to desired shape
 - Heat treat spinner
 - Weld and pin spinner to mounting rod
 - Mount sprockets to spinner motor and spinner rod
 - Mount spinner to bot via bearings
- Assemble electrical components
 - Wire power switches
 - One for all power
 - One for each wheel
 - One for spinner only
 - Wire-up motors for wheels
 - Wire and program electrical speed control components
 - Connect wheel motors and battery
 - Wire-up motor for spinner
 - Wire remote controller on/off switch
 - Connect to battery and motor
- Connect RC receiver
 - Wire to low voltage BEC on motor controller
 - Connect to electric speed controls and remote on/off switch
- Program remote control

- Connect batteries to check function
- Complete remaining metal work
 - Build spinner motor mounts out of angle iron
 - Mount spinner motor buckets to motor and bottom plate
 - Cut and form top plate from 0.25" Aluminum sheet metal
 - Mount batteries and pad the battery box
 - Mount top plate
 - Mounted via bolts
 - Mount diamond plate to outside of bot
 - Mounted via bolts
- Finishing and testing
 - Check all screws and bolts are tight
 - Add any additional needed fasteners
 - Ensure rigidity of structure
 - Attach chain to spinner motor and spinner
 - Test function of remote control
 - Test function of wheel assemblies
 - Test function of spinner
 - Check structure after tests
 - Paint desired surfaces
 - Add any desired decals
- Complete presentation and final report about our battlebot project

Expected Findings:

We began the research on our battlebot on September 4, 2020. We studied the Battlebots Rules so we could get a list of parts that our bot had to have in order to compete. Once the necessary parts were determined, we began looking at other battlebots to draw inspiration from. We knew we wanted to have some sort of spinner of the front as the weapon because of the high success rate of these types of battlebots. We then began to sketch out our battlebot until we obtained our desired design. This design was transferred from sketch paper to a Fusion 360 3D model. Once the 3D model was made, we picked out the rest of the components (metal, wheel, motors, electrical parts, etc) based of their size and power. Using the components list, we were able to create a budget and weight estimate to make sure we were within the Battlebots Rules and within our expected budget. We gained approval of our projects on October 28th. We sent in a proposal and a scholarship request form for the Armin Fleck scholarship. Our request was accepted, and we were able to gain our funding. We would like to give a special thanks to them. Our battlebot project would not have been able to be this large without their support. After receiving the funding, we began ordering parts immediately by submitting order forms to Miami University so our parts could be here before December 5, 2020. We were also able to secure use of Shawnee State University's machine shop, so we have a place to begin working on our battlebot.

As is displayed in the Timeline below [Appendix], the frame construction will take the longest, and it is the base for our project. We are going to take the 6061 1/4-inch side plate and the 5052 1/4-inch top and bottom plate aluminum, cut it into the desired shapes, and then weld it together. We expect to have to overcome some difficulties in welding this material. We plan custom fit bracing as needed to the interior of the frame to improve strength. Once that is

complete, we will begin to work on milling out the spinner and getting it heat treated and mounted. When we heat treat the cylinder, we will have to be careful not to warp it. Machining this spinner will take place at Shawnee State University's machining lab. The electrical components will be the last parts added. This will present multiple challenges. We will have to learn how to program the motor controllers. We will also have to learn how to program the transmitter for our intended use. We will have to effectively mount our components to ensure they can withstand jarring forces. We plan on being done by March 8th, 2021. This will give us plenty of time to test and do minor tweaks before our final presentation on April 23rd, 2021.

Parts for the battlebot began being ordered on December 7th. Due to shipping delays caused by Covid-19, we received enough parts to begin construction on the battlebot on January

15th. The first action we took was laying out the bottom plate. We placed our wheel assemblies, batteries, and spinner motor on one of the 24" x 24" x 1/4" pieces of aluminum to get a visual of the location of the various components in the battlebot. This can be seen on the right in *Figure 1*. The cut



Figure 1

lines were then marked on the bottom sheet of aluminum using the dimensions from the sheet created on the Inventor software. We immediately noticed a necessary adjustment. The original dimension for the angle plates that sit on each side of the spinner was 5". This was going to give

our spinner a very tight clearance with the front plate of the battlebot. We decided to increase the length of these two plates to 5.5" to insure adequate clearance.

Braden then cut out the bottom plate using a jigsaw. It can be seen in *Figure 2*. The dimensions can be seen in the Appendix. Nick prepped for welding. Braden cut the side plates from 6" x 18" x 1/4" aluminum to length using a band saw and filed and sanded the edges. Nick welded the plates into place. It is important to note that welding took a good deal of time for



Figure 2

this project. Due to the low temperatures in our workshop, each piece of aluminum had to be heated with a torch prior to welding. The side pieces were set on the bottom plate and lined up flush on the edges. They were welded on the inside edge. The welded frame can be seen in *Figure 3*. Braden then cut the plates to build the battery box.

The battery box was cut from the same material as the side plates. The battery box had to have notches cut in the sides to give enough room for the



Figure 3

wheel motors to intrude as needed. Nick welded the battery box together. It measured 9" wide, outside to outside, and 13.25" long, outside to outside. The box was then fit into place in the

frame by filing protruding edges and welds. Nick welded the box into place as seen in *Figure 4*. This completed the basic frame construction which included the bottom plate, the sides, and the battery box.



Figure 4

Mounting the wheel assemblies was the next step. The wheel

assemblies that we ordered from Robot Marketplace came with the wheel, motor, chain, and sprockets assembled. They did not, however, come with mounting holes. The wheel assemblies were taken apart to drill the necessary mounting holes. The stripped frame of the assembly was placed into the battlebot frame to obtain measurements. The front of the wheel frame was set 6 $\frac{13}{16}$ " back from the inside of the 3" front plate. Two holes were drilled in the wheel assembly frame 3 $\frac{15}{16}$ " back from the front and $\frac{3}{4}$ " up from the bottom and down from the top.

Corresponding holes were drilled in the frame of the battlebot 10 $\frac{3}{4}$ " back from the inside of the 3" front plate. Holes then had to be cut in the bottom plate to allow the wheels to protrude. The front of the hole was 6 $\frac{1}{2}$ " back from the inside of the 3" front plate and the side of the hole closest to the side wall of the battlebot



Figure 5

was 1 ¼” in from the outside of the bot. The rectangular hole measured 2 1/8” wide and 4” long. The hole was cut by drilling starter holes in the corners and cut using a jigsaw. Two ¼” custom shims were cut to hold the wheel assembly off the side plate and off of the weld. The wheel assembly was reassembled and attached with bolts. This same process was used for both the right and left wheel assembly. The attached assemblies can be seen in *Figure 5*.

Next, we began working on the spinner mounts. While Nick was finishing up some welding, Braden cut six custom shims from the left over ¼” aluminum. These shims had a 2” end, a 4” end, a 4 ¾” square side, and an angled side to fit the angled opening present at the front of the battlebot where the spinner mounts would sit. Two holes were drilled in the shims and each side of the battlebot bottom plate to match the spinner mount bearing holders. The



Figure 6

bearings were bolted into place as seen in *Figure 6*. Nick lined up the mounts and began working on laying out the holes for the spinner. One side received a hole and the other received a notch to make removing the spinner possible.

While Nick worked on lining up the spinner mounts and holes, Braden began working on designing the bracing system. We decided to build a custom fit and removable interior bracing

system. The bracing was mainly constructed from 1" x 1" x 1/8" aluminum angle. The angle was cut to fit along the interior of the side plates and battery box. It was held down 1/2" from the top of the side plates. The bracing was mounted by drilling holes through the side plates and using bolts. When all the bracing was in place, it was welded together into a single piece that could easily be removed from the bot by removing the necessary bolts. A piece of 1" x 1" aluminum bar was run perpendicular to the battery box at the rear angle of the bot to add extra strength to these areas. *Figures 7 and 8* depict the bracing.

The next step was to mill the spinner and the spinner motor mount. We designed these and took them the Shawnee State University to use their machine shop. We were assisted by one of the SSU professors at the university, Jeff Spriggs. Jeff helped us mill the spinner using Shawnee's CNC machine. We



Figure 7

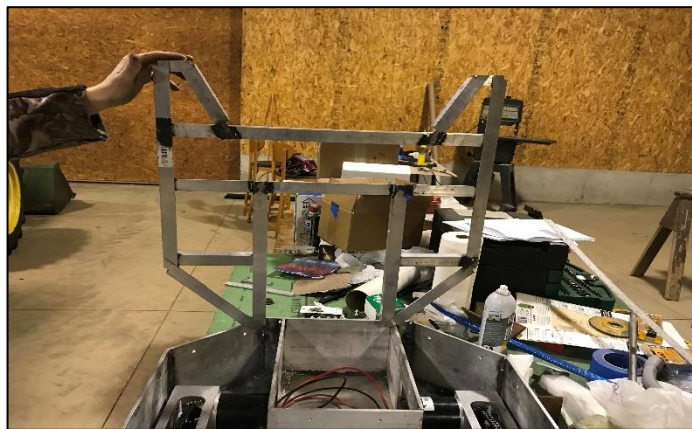

Figure 8



Figure 9

used a 1" endmill to do the cutting on the spinner. We cut the 1" section out of the center of both sides of the spinner first. We then cut on a 45 degree to the 1" section. We then drilled a 5/8" hole in both ends of the spinner using a lathe. The weight of the spinner was measured to be 15 pounds. The motor mount was milled using an endmill and a 3/16 drill bit. The spinner can be seen in *Figure 9*.

The spinner was then mounted. A 5/8" steel rod was hammered into each side of the spinner. The side rods were cut to length after they were seated. The #25 18 tooth sprocket was put on the right front side of the spinner. The spinner was then put through the hole in the side plate and lowered through the notch in the other side. The 5/8" rod was inserted into the bearings on each side. The spinner was centered and the set screws in the bearings were

tightened. The spinner was aligned with the same distance between both sides and the back wall and the mounts were bolted down. The spinner motor was bolted to the spinner motor mount. The mount was bolted to the bottom plate with a piece of 1/4" aluminum plate in between them. The



Figure 10

#25 23 tooth sprocket was placed on the spinner motor. Holes were drilled into the front plate to allow the chain to pass through. The chain was attached to both sprockets. A custom chain tensioner was built using a piece of 1"x1"x1/8" aluminum angle and a bearing. This piece was attached using a bolt to the interior bracing. The attached spinner is visible in *Figure 10*.

Next, the rear wheel mounts were built, and the wheels were attached. The rear wheel mounts were built from 1" x 1" x 1/8" aluminum angle and 2" x 1/8" aluminum bar stock. The

holes for the wheels were cut in the bottom plate using a drill for starter holes and a jigsaw. The holes were cut with the back of the hole $2\frac{3}{4}$ " from the inside of the back plate and the side of the hole 1" off of the battery box. The side mounting brackets were cut out of 1" x 1" x $\frac{1}{8}$ " aluminum and mounted to the side plate and battery box using bolts.

The bottom of the mounts were cut from 2" x $\frac{1}{8}$ " aluminum bar stock. Three of these pieces were bolted to the bottom of the angle. The wheels were centered



Figure 11

in the bottom hole and mounted to the bottom of the mounts. The side angle pieces were then adjusted until approximately $\frac{1}{8}$ " of space was visible between the back of the bottom plate and the ground. The bolts were tightened with blue Loctite applied. This process was used to assemble both of the rear wheels. One of the rear wheel mounts is pictured in *Figure 11*.

The battery cables and manual on/off switches were next added to the battlebot. The switches were attached by taking and 2" x 2" x $\frac{1}{8}$ " piece of aluminum and cutting holes to fit the switches equidistant apart. This switch shelf was then attached to the front of the battery box by the existing bolts that were used



Figure 12

to hold the bracing. The test leads for the battery cables were then created using 10-gauge wire and male and female connectors. To help clean up the wiring in the battlebot, we added a

grounding strip and a positive lead terminal strip. The grounding strip had the battery ground connected to it as well as the negative leads from the wheels and spinner ESCs. The positive of the battery connected straight to a 70-amp switch, then the other lead of the switch connected to the positive lead terminal strip. This was so we could shut power off to the positive lead terminal switch stopping all power to the rest of the battlebot. The positive leads of the wheel switches and spinner switch was then connected to the positive lead terminal strip. The other end of the leads was then connected to the positive end of their respective ESC. This allowed us to turn power off to each component while still allowing power flow to the others. However, both left and right wheels were connected to the same switch, so they were powered together. The upgraded 70-amp switches are visible in *Figure 12* above.

After installing the on/off switches we then wired in the ESCs for the left and right wheel assemblies. This required us to run a positive and negative lead from the battery into the ESCs and then the positive and negative leads from the motor separately. The ESCs then had to be wired together so they could communicate and run accordingly with the other. At this point we also wired the 6V BEC from an ESC to the receiver to power it, and we connected the motor controllers to the correct signal pins on the receiver. The RC

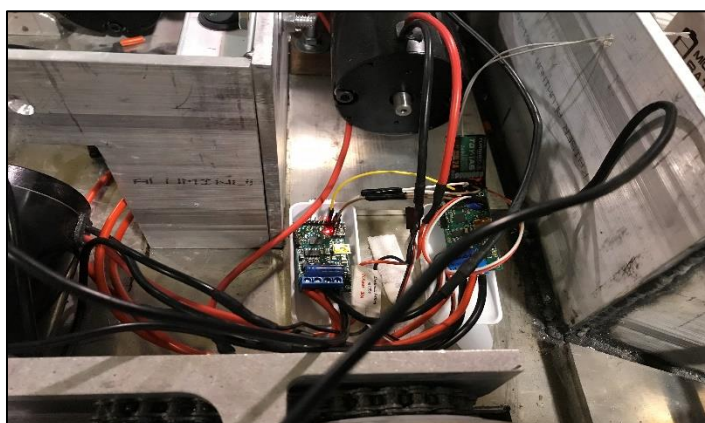

Figure 13

transmitter came preprogrammed and connected to the RC receiver. We adjusted what channels were controlled by what switches, but this was the only alteration made to the transmitter. The ESC required some minor programming done. The ESC came with downloadable easy-to-use

software that allowed us to choose the necessary information and adjustments. This included which wheel was the left or right, what percentage of voltage we wanted to use for the forward and reverse. We also had to program our neutral position so that it matched our controller. The percentage of braking had to be programmed as well. We did not want the motors to brake at 100 percent or they would draw too many amps when slowing down. The ESCs are shown with the original RC on/off switch and the receiver in *Figure 13*.

Next, we worked on the RC on/off switch for the spinner motor. We began by wiring in our RC on/off switch that we had originally ordered. It immediately burnt up and the motor did not turn. We replaced that switch with a higher amp rated one, but it also did not work. This is when we decided to switch to a relay system because they withstand higher amperage than the small switches we were using. We finally got the motor

to turn on and stay on with a 70-amp relay system and inline fuses. At that point we knew that it would blow a 40-amp fuse but not a 50-amp fuse on start up. Later when we got a voltmeter that could read that high of amperage, we measured a slow start starting amperage to be 18 amps, but when it got up to speed, it was pulling 46

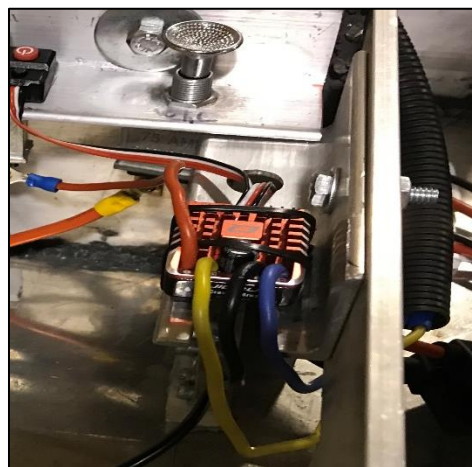

Figure 14

amps. This still did not work to our satisfaction and we ordered an 80A ESC to replace the whole relay system we had. When that ESC arrived, we immediately put it on. It was as easy to install as the others. The positive and negative of the battery connect to one half and the positive and negative motors connect to the other half. This came with a programming box. All we had to do was set the ESC to predetermined modes that best fit our needs. This included switching the motor controllers from having a reverse setting to

just having a Forward/Neutral/ Brake setting. Another setting was the braking power. We set it to 45 percent because the spinner weighed 12 pounds. This ESC allowed us to turn the spinner motor on slowly to reduce the immediate amperage draw. The ESC is displayed in *Figure 14*. Our original on/off toggle switches were only rated for 20 amps. We had to replace them with 70-amp push/pull toggles switches.

Once the electrical was figured out and worked to our standards, we began cutting our top plate and working on cutting out the diamond plate armor. The top plate was cut to the exact dimensions of the bot, so it sat flush with the sides. A slot was cut in the ¼” top plate and three holes had to be drilled in the top of the diamond plate, right above the switches, so they were easily accessible. Another smaller whole was drilled so we could fit our RC receiver wires out the top. To attach the top plate to the battlebot, we ran bolts through the support bracing close to the four corners. Holes were cut in the top to match, and the top plate was fastened on with 4 nuts and



Figure 15

washers. We made the diamond plate side pieces a ¼” smaller all around and the top pieces ½” smaller all the way around in size to give us an offset look to the diamond plate. On the front piece behind the spinner, we made the size 1 inch smaller to give us plenty of room for the chain holes. The diamond plate was mounted on using the pre-existing bolts that held on the internal support frame. The rear most plate had to have holes cut because the support frame did not attach to that side. The two 2 ½” pieces in the front also had to have holes and bolts attached because of the same reason. When we had our diamond plate pieces placed where we liked

them, we took all of it off and spray painted the underneath black to contrast the mirror like finish of the diamond plate. The armor can be seen in *Figure 15*.

After being milled for the first time, our spinner weighed 15 pounds. We decided to have it milled again so we could reduce the weight. We took it back down and drilled five holes in the center of the groove that was cut. We then milled off three 2" sections of both



Figure 16

round sides of the spinner. After making these adjustments we brought our weight down to 12 pounds. The updated spinner is visible in *Figure 16*.

We had yet to make a battery holder. The design we came up with was inspired by a tractor battery holder that had two bolts and a piece of metal that pulled the battery against another piece that held the battery still. We welded one piece of 2" aluminum angle that was just slightly higher than the battery and placed a foam strip to keep the battery from rubbing against the metal on top. A second



Figure 17

piece was cut an inch shorter in length and was used as the free-floating piece that got pulled to hold the battery in place. Bolt holes were cut and one bolt on each side of the battery was ran through and tightened down to hold the battery in place. The mount is show in *Figure 17*.

During our testing we noticed that in transition from full speed to reverse our wheel ESCs would shut off. This would not be good for us in a match situation. Consequently, we decided to replace the wheels ESC with the same type of ESC that we used for the spinner weapon because we knew it would be able to handle the amperage that the wheel drew. I would like to point out that other than the slight issue of the low amperage ESCs turning off when we did a hard reverse, our battlebot was complete. We took advantage of the time allowed for alterations. The

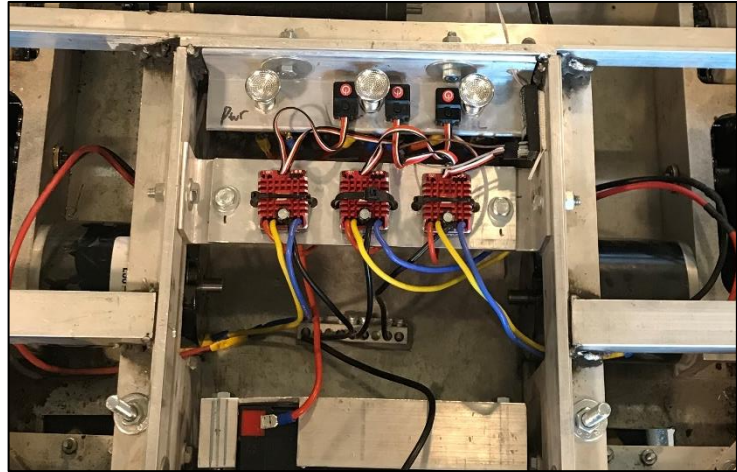

Figure 18

ESC were easily installed, programmed, and worked well by meeting our standards. They were mounted on a piece of 1/8" x 2" aluminum bar with zip ties. The aluminum bar was mounted to the battery box by aluminum angle and bolts. The ESC was rated for 80 amps, and we only had a max wheel amperage of 25 amps. The updated ESCs are displayed in *Figure 18*.

This is when we began our testing. We quickly found a wiring issue with the ESC and receiver. All three of the ESCs had a BEC voltage that powered the receiver. This led to a back-feeding voltage and actually broke the spinner ESC. We had a cheaper spare ESC, but due to overheating, it would only run for 30 seconds before turning off. We ordered another 80A ESC and had to wait for it to arrive and install it before we could resume testing. To get our max amperage for our motors, we set a dyno system for our battlebot to allow for accurate and safe measuring of the amperage. This is when we measured the RPMs to get the total force of the spinner. We decided to test the spinner out on fruit instead of metal due to safety reasons. We

did not have a thick glass like the ones that would normally be present around the arena. Our spinner could easily fling pieces that could injure someone. To get our top speed we set up markers on the ground and timed our battlebot.

Conclusion and Future works:

The end result of our project was a 118lb battlebot affectionately named

Toolbot, seen in Figure 19, because of the diamond plate armor's resemblance to a toolbox. Our battlebot had a custom spinner weapon that

weighed 12lbs. It spun at a laser tachometer measured 8,000 RPM and hit with a calculated force of 1,017 ft-lbs. The max spinner amperage draw was an amp meter measured 59 amps. The battlebot had a top speed of 7.7 MPH and the wheel motors had an amp meter measured max amperage draw of 25 amps each. Running hard and fast, this battlebot could run for approximately 7 seven minutes on one battery charge. The *Toolbot* features a black paint job with chrome diamond plating as armor. Results of



Figure 19

Voltage	
Battery	12V
BEC	6V
Weight	
Spinner	12 lb
Total	118 lb
Battery Life	6 minutes 54 seconds
Current	
Starting Current Spinner	18 Amps
Spinner Running Current	46 Amps
Spinner Max Current	59 Amps
Wheel Starting Current	5 Amps
Wheel Running Current	8 Amps
Wheel Max Current	25 Amps
Speed	
Battlebot Top Speed	7.7 MPH
Top Speed of Spinner	8000 RPM
Spinner Force	1017 lb-ft

Figure 20

the tests are displayed in *Figure 20*. The final cost of the battlebot came in at \$2626.55 which is \$126.55 over our projected \$2500 budget. The full budget can be seen in the Appendix section. The reason for this overage is mainly due to the cost of changing the spinner control from a remote on/off switch to an ESC and upgrading the wheel ESCs. There was also some extra cost in our custom interior bracing that was designed after construction began. The poster and presentation for this project show the original total money spent through the Fleck scholarship as \$1954.50 because this is the original amount, we were presented with giving our project a total cost of \$2540.20. After being given the receipts for all of the Fleck items, we tallied a total of \$2026.08 spent through the Armin Fleck orders giving us the \$2626.55 total.





Overall, our design met and exceeded our expectations, but there is still room for improvement. It would have been great to build this project out of titanium because it would increase the battlebot's durability. With more time, we could have taken the spinner back to Shawnee to have it milled another time. Teeth would have been added into the spinner, so it would do more damage when hitting objects. A gear box would have been another improvement to the spinner mechanism. The gearbox would cut down the speed, but we would have a greater amount of torque behind the spinner. Therefore, it would not bog down as much when hitting an object. There is also extra space in the interior of the battlebot that we could get rid of or add more support structures to make our battlebot stronger. Upgrading the RC controller would also be an improvement. Our current controller only has one of the main toggle switches sprung, and this makes certain maneuvers with the battlebot difficult. Upgrading the battery is another possibility. Upgrading to something lighter with more component compatibility, such as a LiPo battery, would be an improvement. Finally, upgrading the motors could improve the battlebot's overall speed and power.

References:

- [1] “Titanium vs Aluminum: Workhorse Metals for Machining, 3D Printing,” *Protolabs*. [Online]. Available: <https://www.protolabs.com/resources/blog/titanium-vs-aluminum-workhorse-metals-for-machining-and-3d-printing/>. [Accessed: 27-Nov-2020].
- [2] “Hello Online Metals Shopper!,” *ShieldSquare Captcha*. [Online]. Available: <https://www.onlinemetals.com/buy/material?q=%3Aprice-asc%3AMaterial%3ATitanium%3AShape%3ASheet%2FPlate%3AAlloy%3AGrade+2%3AThickness%3A0.25%22>. [Accessed: 27-Nov-2020].
- [3] Earle M. Jorgensen Company, *Earle M. Jorgensen Reference Book: Weight Tanles*. © Copyright 2007 Earle M. Jorgensen Company.
- [4] “BattleBots Tournament Rules 2020,” *BattleBots*. [Online]. Available: <https://battlebots.com/rules/>. [Accessed: 27-Nov-2020].
- [5] “High Performance Economy Motors,” *Three-Inch High Performance Motor*. [Online]. Available: https://www.ampflow.com/three_inch_high_performance_motors.htm. [Accessed: 27-Nov-2020].
- [6] “BattleBots Battery Rules,” *BattleBots*. [Online]. Available: <https://battlebots.com/rules/>. [Accessed: 27-Nov-2020].
- [7] “Calculator: Sizing a 12 Volt Battery to a Load,” *BatteryStuff.com: We Have The Stuff*. [Online]. Available: <https://www.batterystuff.com/kb/tools/calculator-sizing-a-battery-to-a-load.html>. [Accessed: 28-Nov-2020].
- [8] “Pololu Simple High-Power Motor Controller 24v12 User's Guide,” *Pololu - Pololu Simple High-Power Motor Controller 24v12 (Fully Assembled) #1378*. [Online]. Available: <https://www.robotmarketplace.com/products/0-1378.html>. [Accessed: 28-Nov-2020].
- [9] O. Liang, “What are ESC, UBEC and BEC,” *Oscar Liang*, 26-Nov-2016. [Online]. Available: <https://oscarliang.com/what-is-esc-ubec-bec-quadcopter/>. [Accessed: 28-Nov-2020].
- [10] “r/battlebots - The best Controller/Transmitter for any battlebot!,” *reddit*. [Online]. Available: https://www.reddit.com/r/battlebots/comments/93xidl/the_best_controllertransmitter_for_a_ny_battlebot/. [Accessed: 28-Nov-2020].
- [11] “Turnigy TGY-i6 Mode 2 AFHDS Transmitter and 6CH Receiver,” *Hobbyking*. [Online]. Available: https://hobbyking.com/en_us/turnigy-tgy-i6-afhds-transmitter-and-6ch-receiver-mode-2.html. [Accessed: 28-Nov-2020].

- [12] “Minotaur (Brazil),” *Battlebots Wiki*. [Online]. Available: [https://battlebots.fandom.com/wiki/Minotaur_\(Brazil\)](https://battlebots.fandom.com/wiki/Minotaur_(Brazil)). [Accessed: 28-Nov-2020].

Appendix:
Final Timeline Gantt Chart:

Epic	SEP '20	OCT - DEC '20	JAN - MAR	APR
<ul style="list-style-type: none"> + BAT-2 Project Selection DONE  				
<ul style="list-style-type: none"> v BAT-4 Design DONE <ul style="list-style-type: none"> <input checked="" type="checkbox"/> BAT-3 Sketch of battlebot DONE <input checked="" type="checkbox"/> BAT-4 Weapon choice DONE <input checked="" type="checkbox"/> BAT-5 Wheel type DONE <input checked="" type="checkbox"/> BAT-6 Batteries DONE <input checked="" type="checkbox"/> BAT-7 Motors DONE <input checked="" type="checkbox"/> BAT-8 RC controls and accessories DONE <input checked="" type="checkbox"/> BAT-9 Shell DONE <input checked="" type="checkbox"/> BAT-10 Drive system DONE <input checked="" type="checkbox"/> BAT-14 Research DONE <input checked="" type="checkbox"/> BAT-17 Frame DONE 				
<ul style="list-style-type: none"> > BAT-15 Budget DONE 				
<ul style="list-style-type: none"> v BAT-11 Proposal DONE <ul style="list-style-type: none"> <input checked="" type="checkbox"/> BAT-39 Proposal Document DONE <input checked="" type="checkbox"/> BAT-40 Jira Timeline DONE <input checked="" type="checkbox"/> BAT-41 Budget DONE <input checked="" type="checkbox"/> BAT-42 Step by Step DONE 				
<ul style="list-style-type: none"> v BAT-13 Order Log DONE <ul style="list-style-type: none"> <input checked="" type="checkbox"/> BAT-24 Wheel assemblies DONE <input checked="" type="checkbox"/> BAT-25 Weapon Motor DONE <input checked="" type="checkbox"/> BAT-26 Batteries DONE <input checked="" type="checkbox"/> BAT-27 Aluminum stock DONE <input checked="" type="checkbox"/> BAT-28 Steel stock DONE <input checked="" type="checkbox"/> BAT-29 Sheet metal (aluminum) DONE <input checked="" type="checkbox"/> BAT-30 Various nuts, bolts, brackets DONE <input checked="" type="checkbox"/> BAT-31 RC controller and components DONE <input checked="" type="checkbox"/> BAT-32 Wiring components DONE <input checked="" type="checkbox"/> BAT-33 Weapon and components DONE <input checked="" type="checkbox"/> BAT-74 Battery Insulation/padding DONE 				

<ul style="list-style-type: none"> <div style="display: flex; align-items: center;"> ▼ BAT-53 Spinner Tasks DONE </div> <ul style="list-style-type: none"> <input checked="" type="checkbox"/> BAT-54 Machine spinner DONE <input checked="" type="checkbox"/> BAT-56 Cut and fit spinner rod DONE <input checked="" type="checkbox"/> BAT-57 Pin and weld spinner to rod DONE <input checked="" type="checkbox"/> BAT-58 Attach sprocket to spinner rod DONE <input checked="" type="checkbox"/> BAT-59 Attach sprocket to spinner motor DONE <input checked="" type="checkbox"/> BAT-60 Mount spinner motor to frame an... DONE 				
<ul style="list-style-type: none"> <div style="display: flex; align-items: center;"> ▼ BAT-47 Electrical Tasks DONE </div> <ul style="list-style-type: none"> <input checked="" type="checkbox"/> BAT-48 Connect Motors DONE <input checked="" type="checkbox"/> BAT-49 Connect RC components DONE <input checked="" type="checkbox"/> BAT-50 Wire in main power switch DONE <input checked="" type="checkbox"/> BAT-51 Wire in weapon power switch DONE <input checked="" type="checkbox"/> BAT-52 Wire in batteries DONE <input checked="" type="checkbox"/> BAT-74 Connect Electronic speed control DONE <input checked="" type="checkbox"/> BAT-72 Connect remote on/off spinner s... DONE <input checked="" type="checkbox"/> BAT-73 Program remote DONE 				
<ul style="list-style-type: none"> <div style="display: flex; align-items: center;"> ▼ BAT-78 Cosmetics and Exterior DONE </div> <ul style="list-style-type: none"> <input checked="" type="checkbox"/> BAT-79 Mount Diamond Plate Armor DONE <input checked="" type="checkbox"/> BAT-80 Paint DONE <input checked="" type="checkbox"/> BAT-82 Cut Top Plate DONE 				
<ul style="list-style-type: none"> <div style="display: flex; align-items: center;"> ▼ BAT-19 Testing DONE </div> <ul style="list-style-type: none"> <input checked="" type="checkbox"/> BAT-84 Test motors for function DONE <input checked="" type="checkbox"/> BAT-68 Test battery life DONE <input checked="" type="checkbox"/> BAT-69 Test speed DONE <input checked="" type="checkbox"/> BAT-70 Test cutting ability and capability... DONE <input checked="" type="checkbox"/> BAT-85 Test weight DONE 				
<ul style="list-style-type: none"> <div style="display: flex; align-items: center;"> ▼ BAT-20 Presentation DONE </div> <ul style="list-style-type: none"> <input checked="" type="checkbox"/> BAT-75 Midterm Presentation DONE <input checked="" type="checkbox"/> BAT-76 Midterm Report DONE <input checked="" type="checkbox"/> BAT-24 Final report DONE <input checked="" type="checkbox"/> BAT-22 Final Presentation Set up DONE <input checked="" type="checkbox"/> BAT-23 Presentation rehearsal DONE <input checked="" type="checkbox"/> BAT-86 Poster DONE <input checked="" type="checkbox"/> BAT-87 Final Presentation DONE 				

Cost:

Battlebot Budget Breakdown							
Part	Price	Number of Parts	Price for parts needed	Estimated Shipping	Store	Actual Price	Shipping
Spinner motor	109	x1	109	28	Robot Market Place	109	
Wheel motor kit side A	260	x1	260	55	Robot Market Place	259	
Wheel motor kit side B	260	x1	260		Robot Market Place	259	
Polou Motor ESC					Robot Market Place	91.9	69.46
Motor ESC					Pololu	46.95	14.87
Re-placement motors					Amazon	158	0
Batteries	70	x1	70	0	Amazon	69.99	0
Caster wheels	19	x1	19	0	Amazon	15.99	0
3" x 24" steel round stock	129.57	x1	129.57	45	McMaster	139.8	
5/8" x 6' steel round stock	51.15	x1	51.15		McMaster	51.15	
Sprocket 5/8" ID #25	12.67	x1	12.67		McMaster	12.67	
Sprocket 1/2" ID #25	12.42	x1	12.42	60	McMaster	14.42	
Chain #25 1/4" pitch 6'	30.84	x1	30.84		McMaster	30.84	
Chain link connector	1	x2	2		McMaster	3	
Dowel pin 1/8" x2.5" 5 count	12.79	x1	12.79	0	McMaster	12.79	37.89
1" x 1" x 6' Aluminum square stock	38.64	x1	38.64	34	Grainger	25.24	
Bearings 5/8" ID	16.7	x2	33.4	13	Granger	33.4	0
Turnigy transmitter/reciever	56.19	x1	56.19	13	Hobby King	56.19	12.8
Receiver battery pack	8.28	x1	8.28	0	Amazon		
Cable connectors	7.99	x1	7.99	0	Amazon		
Remote on/of switch	8.24	x1	8.24	0	Amazon	5.88	7.99
Electric speed control	44.99	x2	89.98	3	Amazon	37.63	0
On/off switches	7.65	x1	7.65	0	Amazon	6.99	
10 gauge wire	15.48	x1	15.48	0	Amazon	15.48	
12 gauge wire	9.95	x1	9.95	0	Amazon	8.95	
Various connectors	18.99	x1	18.99	0	Amazon	17.99	
Solder electrical and welding	40	x1	40	0	Amazon	14.99	0
7" x 3/8" bolt	1.25	x8	10	0	Lowes		
3/8" lock washers 25 count	4.2	x1	4.2	0	Granger	4.35	
3/8" washers 25 count	3.98	x1	3.98	0	Granger	5.57	
3/8" nut 25 count	3.56	x1	3.56	0	Granger	6.52	
3/8" x 2.5" bolt 25 count	10.35	x1	10.35	0	Granger	8.07	
angle metal (for brackets)	30	x1	30	0	Granger	18	0
#8 x 1/2 in. self-tapping Screws x260	7.21	x1	7.21	0	Home Depot		
1/8" x 12" x 36" diamond plate	41.95	x2	83.9	0	Amazon	83.9	0
1/4" x 24" x 24" 6061 aluminum	88	x2	176	16	eBay	98.82	23.9
paint decals	30	x1	30	0	Amazon		
24" x 24" x 1/8" diamond plate	40	x1	40	20	Amazon	40	
1/4" x 6" x 18" Aluminum 6061	14.2	x7	99.4	49	Amazon	127.8	68.6
Battery box insulation	25	x1	25	0	Amazon		
Battery mounting components	20	x1	20	0	Amazon		
Various other components and shipping	316	x1	316	0	Amazon		
						-99.7	
Totals			\$2,164	\$336.00		1790.57	235.51
			Total Estimate	\$2,500		Armen Fleck Total	\$2,026.08
			Actual Cost	\$2,626.55			
			Over Budget	\$126.72			

Personal Costs Battlebot				
Item	Price	Store	Date	Purchaser
bolts	5.43	RK	4/5/2021	Braden
bolts/fuses	5.07	RK	4/5/2021	Braden
welding accessories	53.57	RK	1/18/2021	Nick
relays, connects, fuses	33.96	Autozone	3/26/2021	Braden
bolts	8.1	RK	3/7/2021	Braden
aluminum bar	13.93	RK	3/4/2021	Braden
blades, wheels, sandpaper	18.61	RK	1/15/2021	Braden
blades, bolts	14.53	RK	1/25/2021	Braden
motor mount bolts	3.39	RK	2/7/2021	Braden
electrical accessories	23.52	Walmart	3/10/2021	Nick
bolts, angle alumium, blades	32.65	RK	2/19/2021	Braden
motor controller	45.03	Amazon	4/9/2021	Braden
motor controllers	90.06	Amazon	4/3/2021	Braden
motor controller	17.15	Amazon	3/25/2021	Braden
motor controller	45.03	Amazon	3/25/2021	Braden
fuseable links	12.95	Amazon	3/21/2021	Braden
electronic on/off	26.67	Amazon	3/19/2021	Braden
flat bolts	26.8	Amazon	3/17/2021	Braden
electronic on/off	26.67	Amazon	3/15/2021	Braden
wires	6.42	Amazon	3/10/2021	Braden
chain links	10.27	Amazon	3/1/2021	Braden
RC relay	14.59	eBay	3/17/2021	Braden
RC relay	14.59	eBay	3/21/2021	Braden
heavy duty on/off switch	51.48	Amazon	3/28/2021	Nick
Paint	0	already had		
motor mount angle iron	0	already had		
washers	0	already had		
Personal Total	600.47			

Weight Analysis:

Weight Analysis Estimate		
Material/Object	Weight (lb)	Components
Aluminum 1/4"	51	1/4" side, back, and front panel; 1/4" top and bottom plate; battery box
Aluminum 1" x 1" bar	4	Bracing
Diamond plate 1/8"	17.5	Outside armour
Spinner	15	3" round bar stock steel milled; 5/8" steel bar
Spinner mounts	3.5	Mounts 5/8" ID
Spinner motor	6	AmpFlow E30-400 12V Motor 1.6hp
Spinner chain and sprockets	1.5	1/4" chain; sprocket ID 1/2"; sprocket ID 5/8"
Wheel assemblies	17.5	Battlekit Single Drive Module A and B; E30 150 motor x2
caster wheels	0.5	2 chaster wheels
Batteries	25.5	Mighty Max Battery 12V 12Ah F2 Razor Battery W15128190003-3 Pack; 4 AA battery pack
Electrical components	1.5	Receiver; electrical speed control x2, remote on/off switch, wire, on/off switches, and connectors
nuts, bolts, welds, brackets, etc.	15	Bolts, nuts, washers, screws, welds, motor brackets, spinner mount brackets,
Total Estimate	158.5	Pounds
*Note: This is a weight estimate. Weight will most likely be slightly more due to excess bracing being installed as needed		
Final Weight	118 lbs	This lower than expected weight is due to the use of 1 battery instead of 3, the lighter than expected spinner, and various other design variances

3D Drawings and Diagrams:
Original 3d Front:

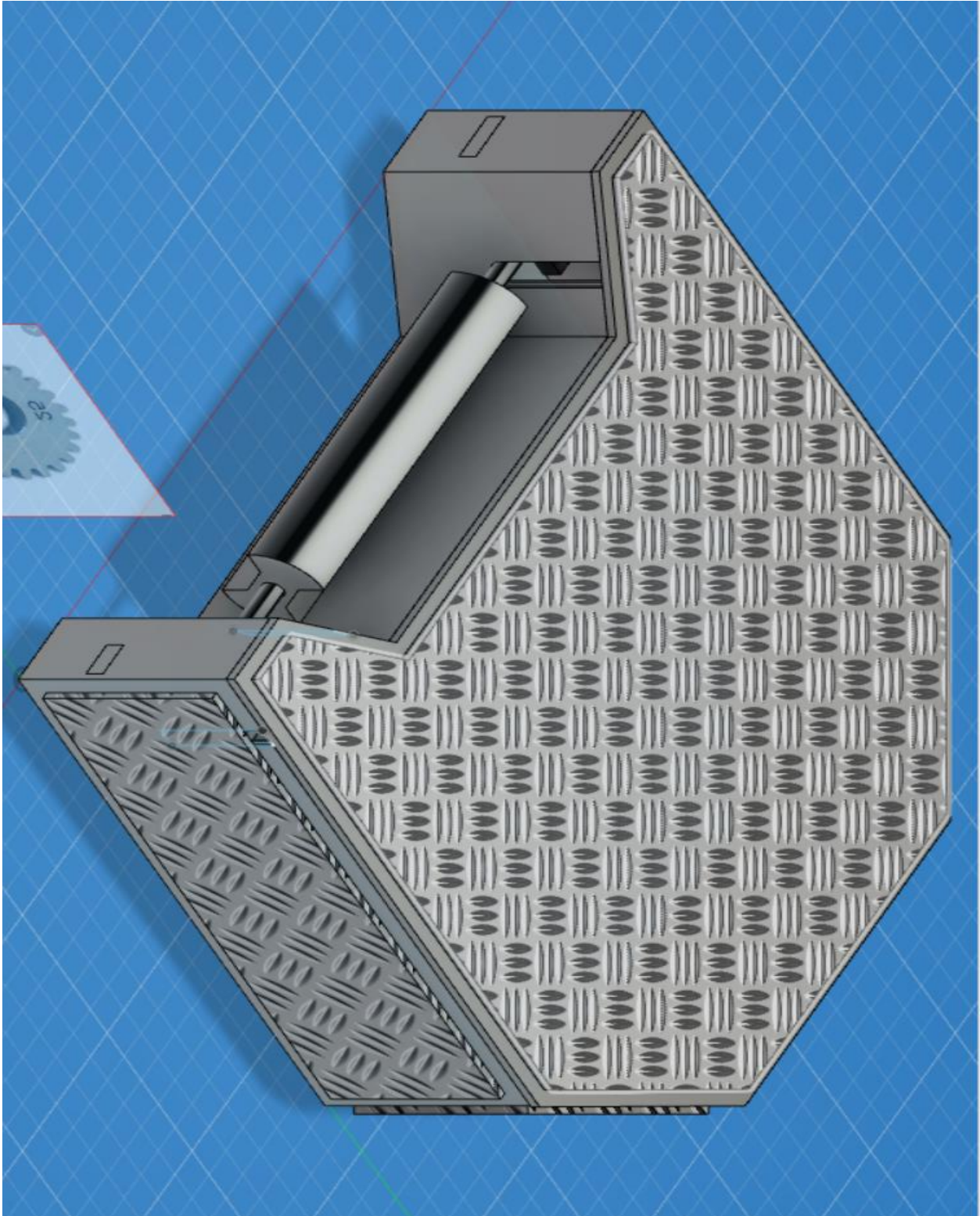

Original 3D Back:

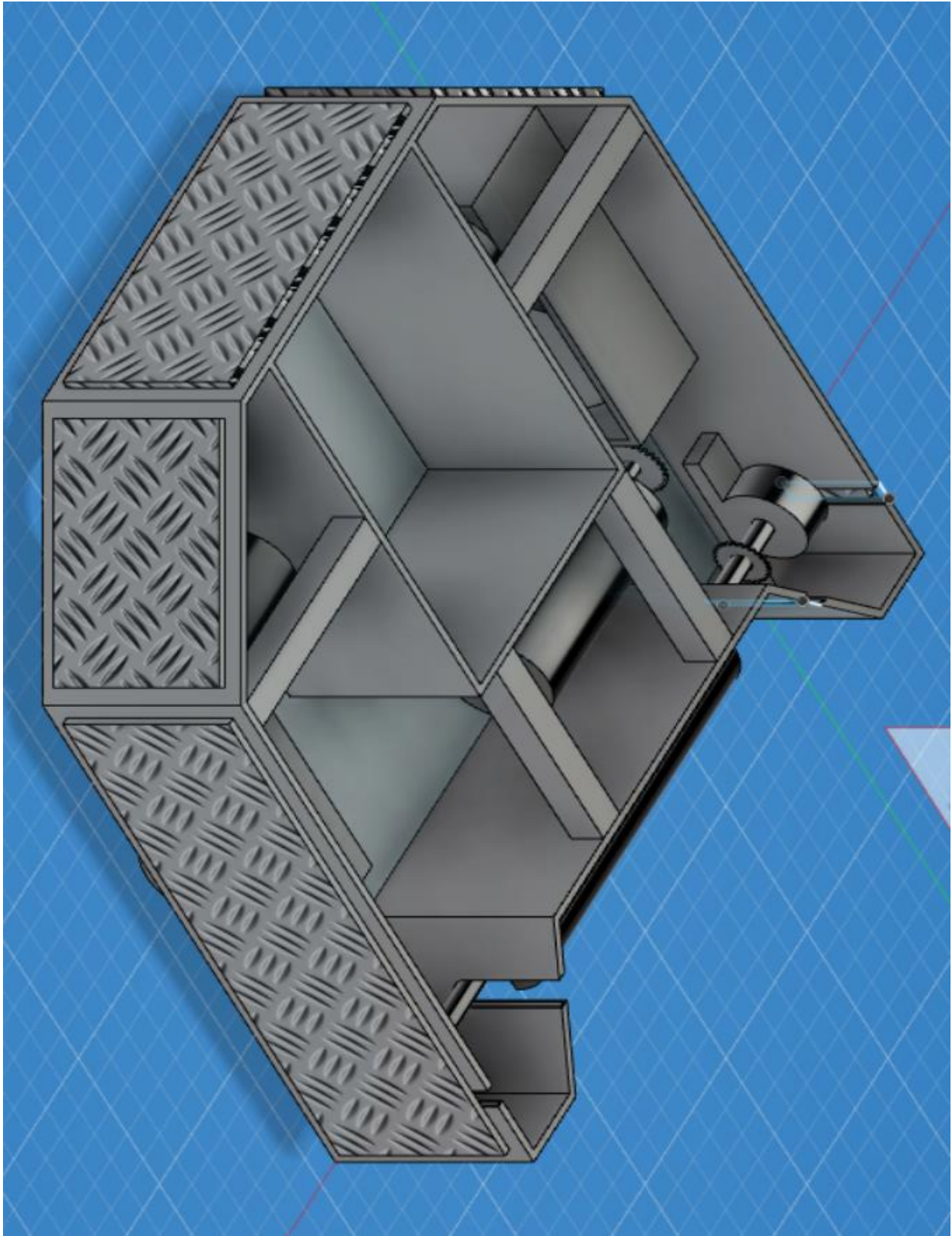

Original Dimensions:

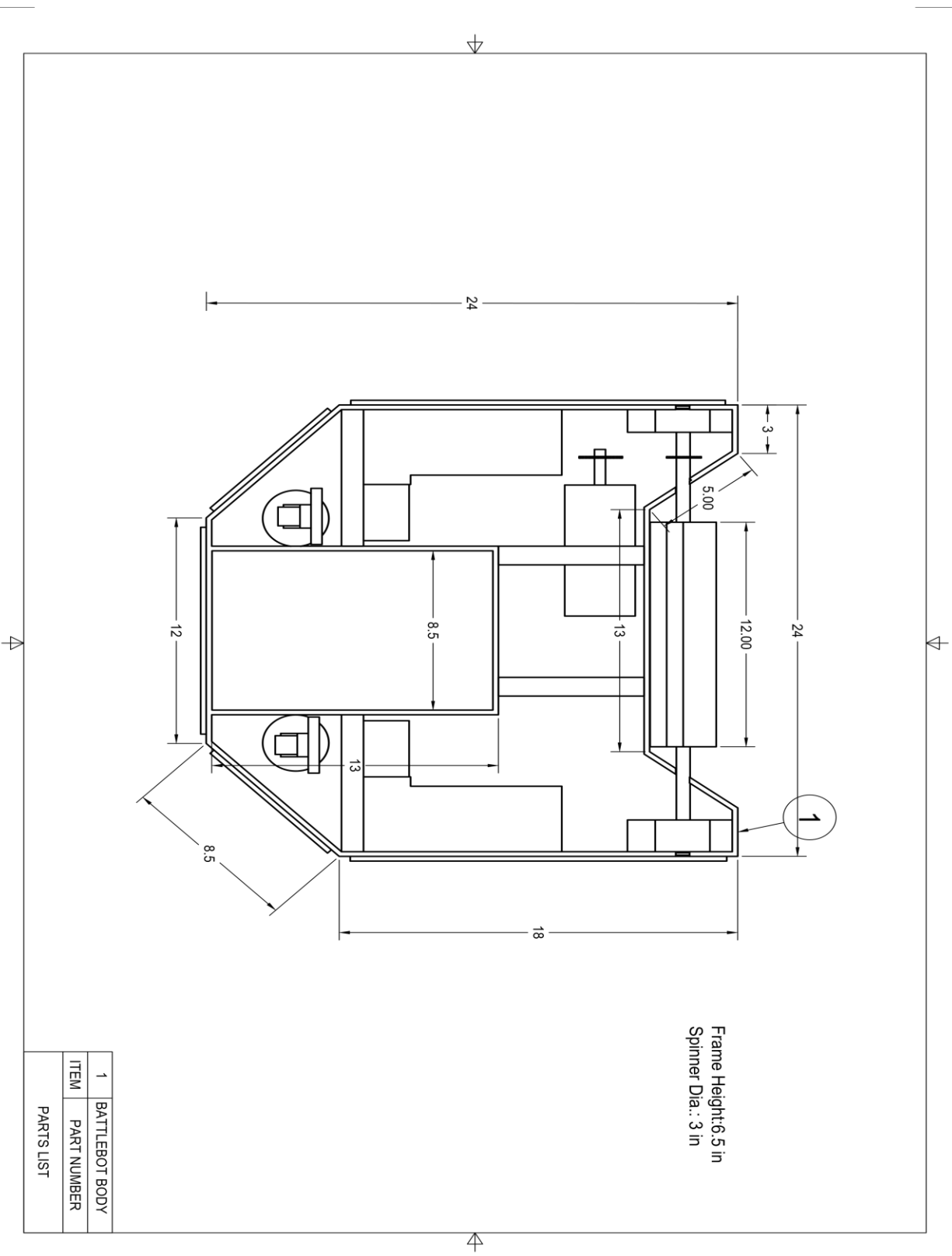

3D Diagram Updated Final:

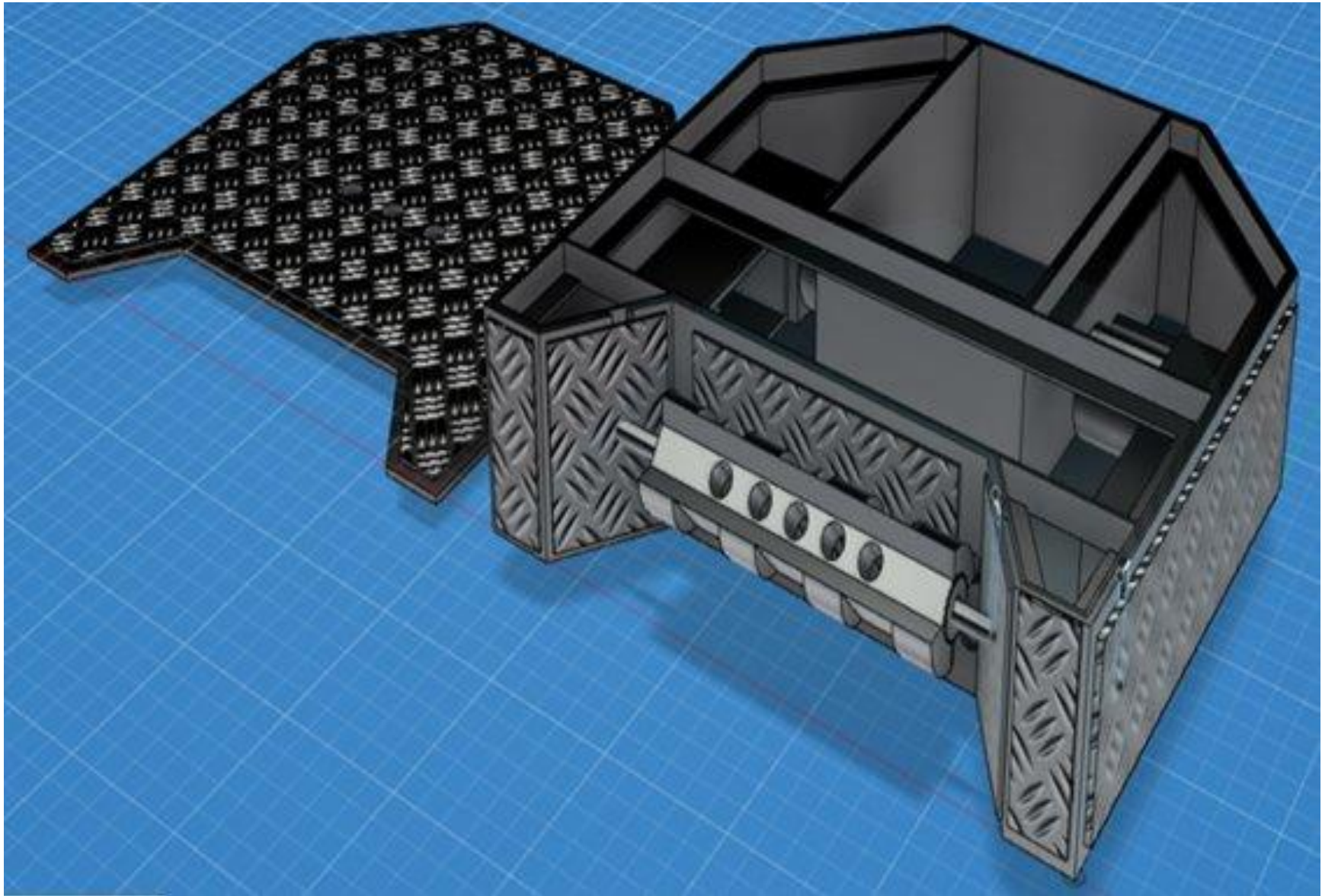

Dimensions Updated Final:

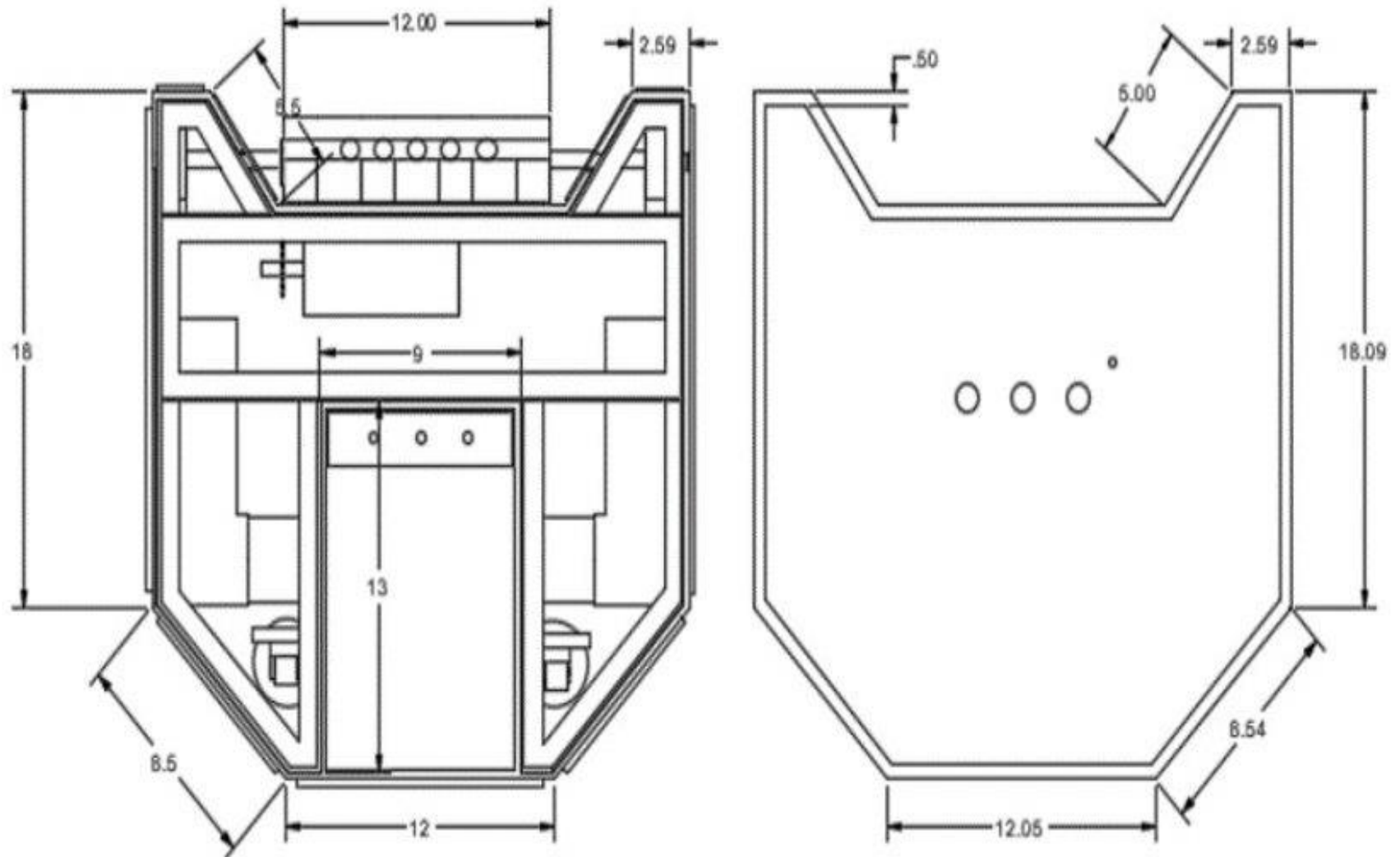

Electrical Design 1 Original:

Electrical Diagram

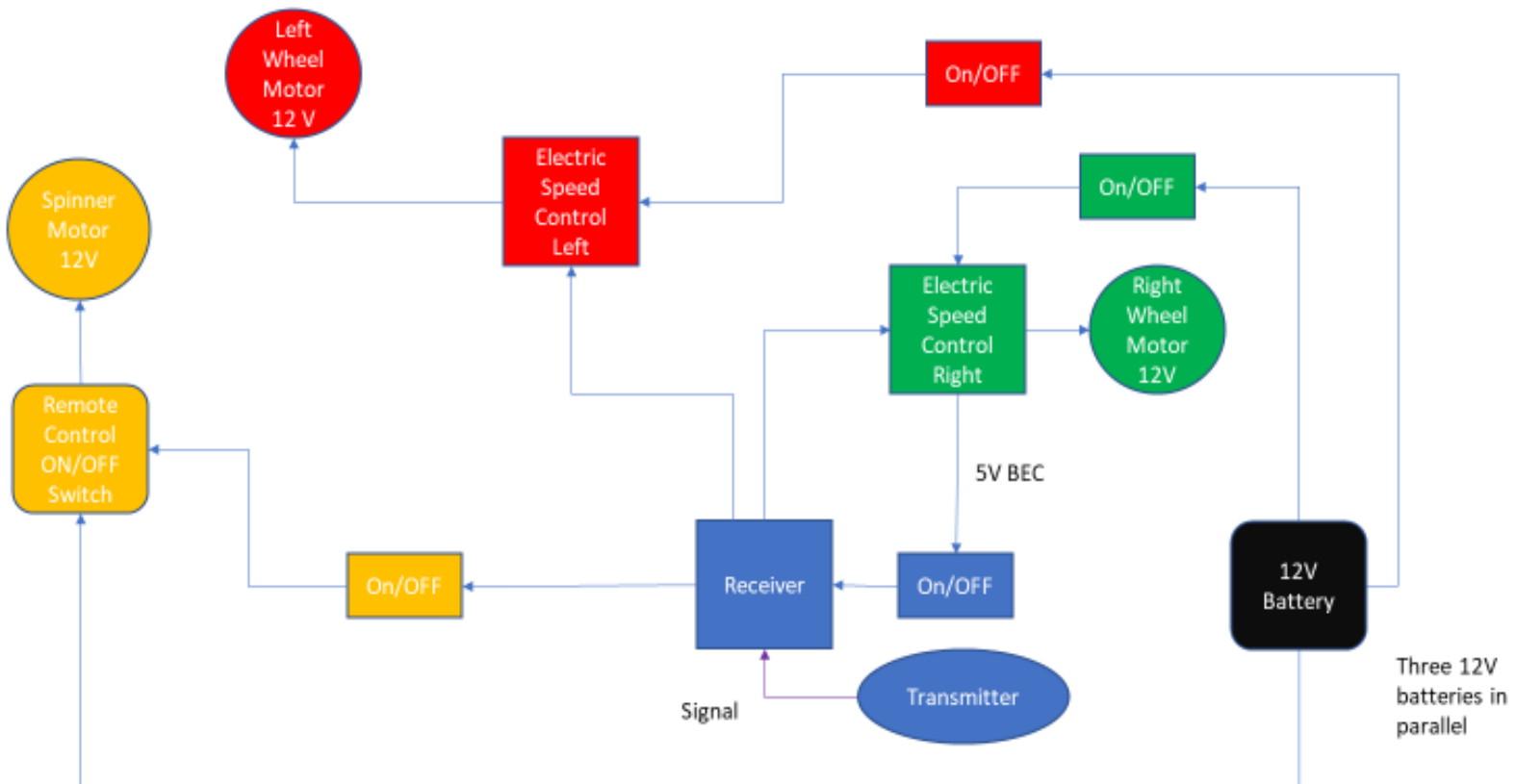

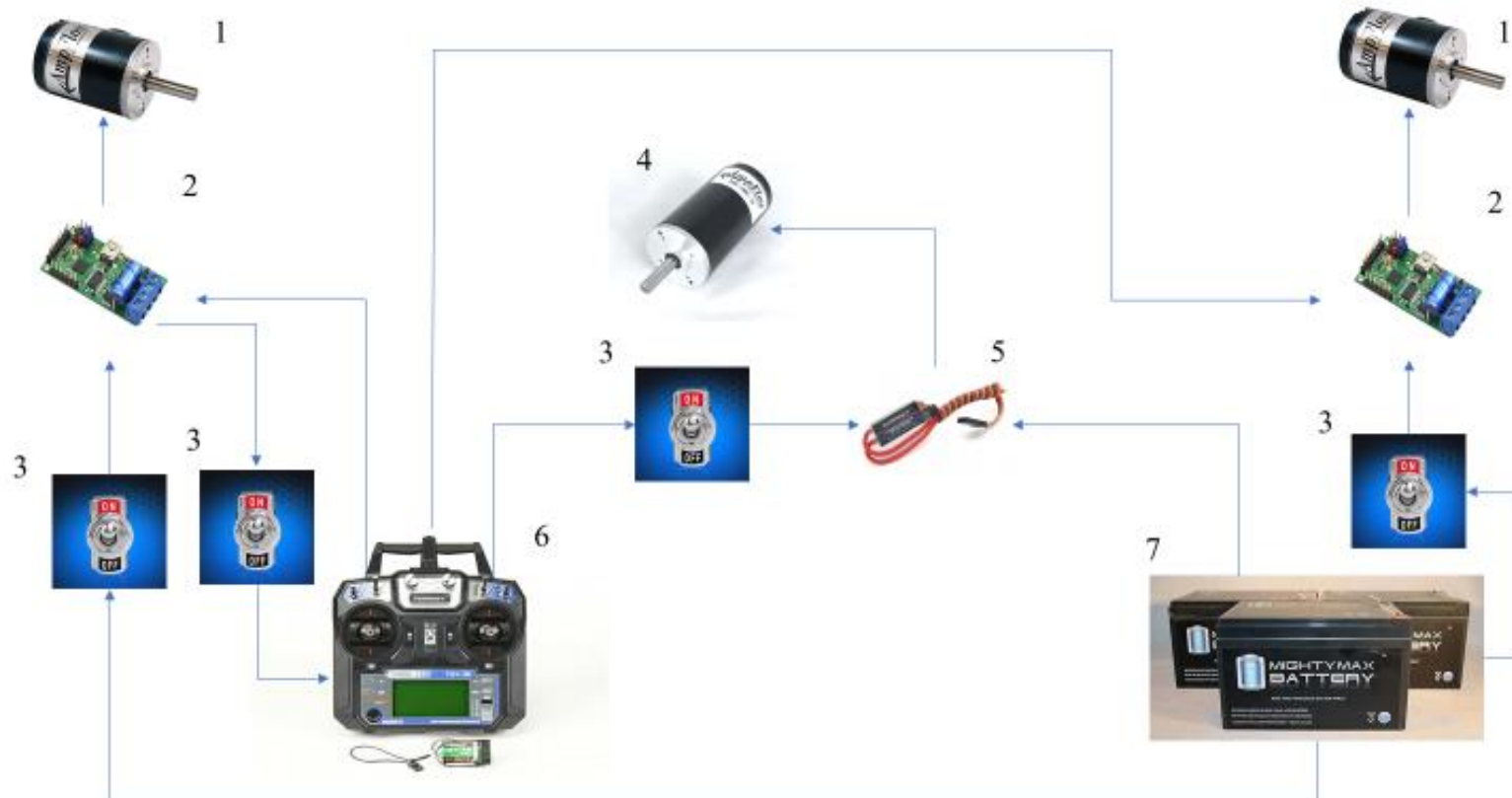
Electrical Design 2 Original:Electrical diagram with components

Electrical Key 2 Original:Key for Diagram

- 1. AmpFlow E30-150 Motor

<https://www.robotmarketplace.com/products/0-e30-150.html>

- 2. Pololu Simple High-Power Motor Controller 24v12 (Fully Assembled)

<https://www.robotmarketplace.com/products/0-1378.html>

- 3. Nilight 90012E Heavy Duty Rocker Toggle 15A 250V 20A 125V SPST 2Pin ON/Off Switch

https://www.amazon.com/Nilight-Rocker-Toggle-Switch-Waterproof/dp/B078KBC5VH/ref=sr_1_3?dchild=1&keywords=On%2Foff+Switch&qid=1601565785&sr=8-3

- 4. AmpFlow E30-400 12V Motor

<https://www.robotmarketplace.com/products/0-e30-400-12.html>

- 5. Turnigy Receiver Controlled Switch

https://hobbyking.com/en_us/turnigy-receiver-controlled-switch-1.html?queryID=630688ec1979eb9e9799a1cc5fe4976a&objectID=45740&indexName=hbk_live_magento_en_us_products

- 6. Turnigy TGY-i6 Mode 2 AFHDS Transmitter and 6CH Receiver

https://hobbyking.com/en_us/turnigy-tgy-i6-afhds-transmitter-and-6ch-receiver-mode-2.html

- 7. Mighty Max Battery 12V 12Ah F2 Razor Battery fits MX500 MX650, W15128190003-3 Pack Brand Product

https://www.amazon.com/Mighty-Max-Battery-W15128190003-3-product/dp/B00K9TJKCQ/ref=pd_rhf_dp_s_pd_cred_1_3/143-1380948-1793745?encoding=UTF8&pd_rd_i=B00K9TJKCQ&pd_rd_r=61f63279-1686-41b8-a1c9-47005aefe58e&pd_rd_w=i2YrV&pd_rd_wg=eLRf4&pf_rd_p=87ee8cc7-5d7a-4ece-95be-f2cfea6744c5&pf_rd_r=A4A743Z96A3W8ZWCWPCZ&psc=1&refRID=A4A743Z96A3W8ZWCWPCZ

Electrical Diagram Updated Final:

Battlebot Electrical Diagram

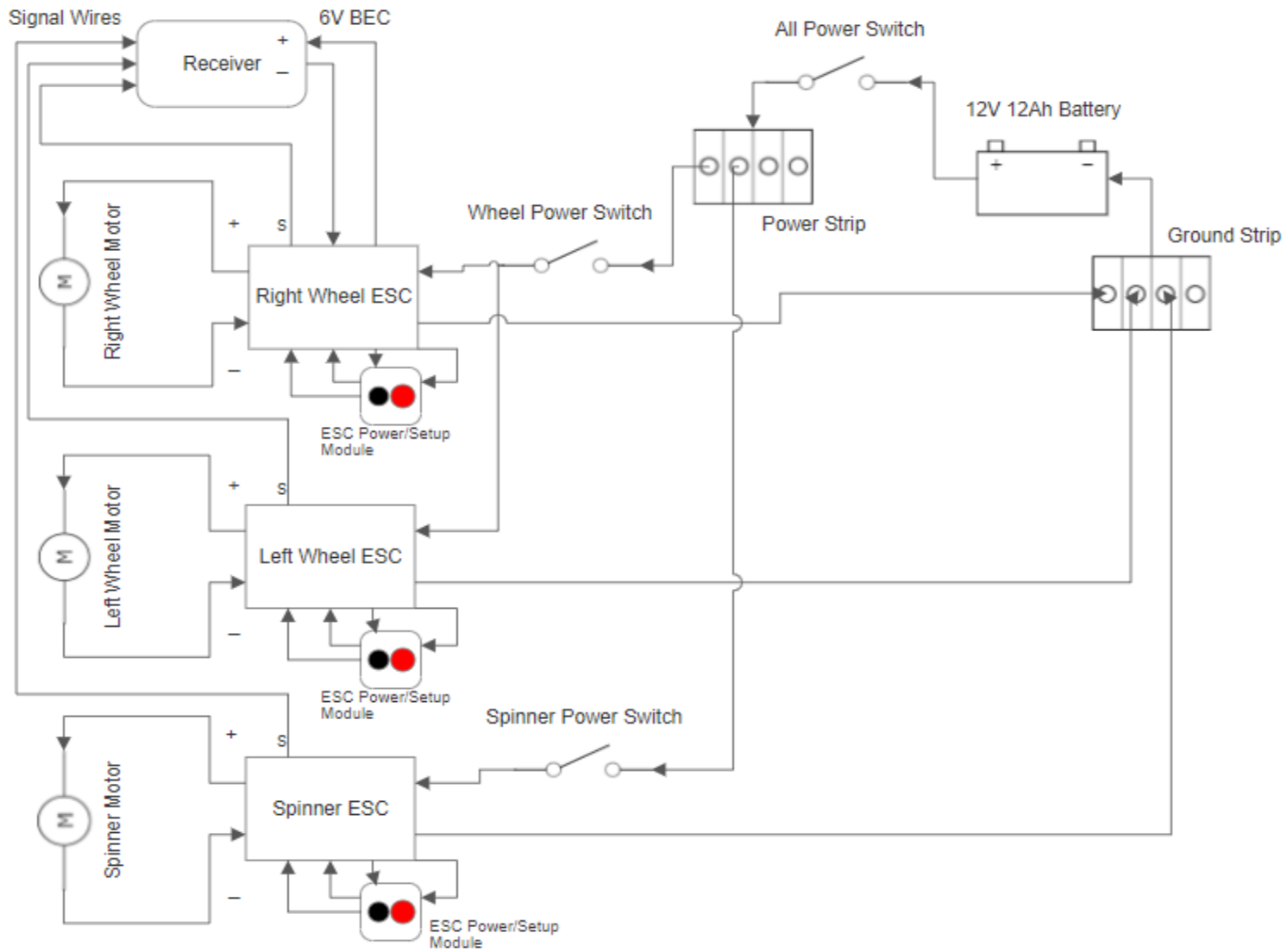

Weapon Motor:

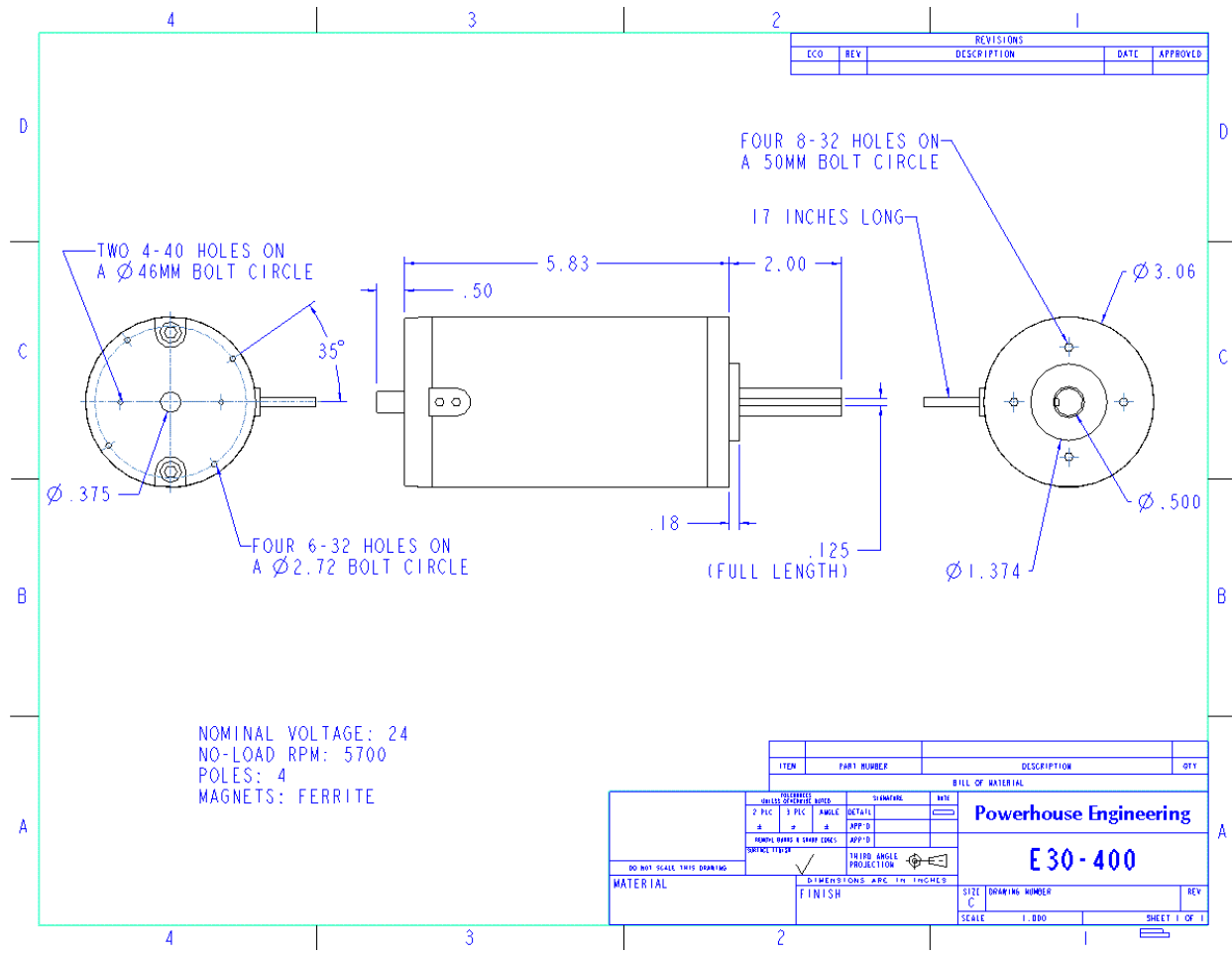

AmpFlow E30-400 12V Motor
<http://www.robotcombat.com/products/images/e30-400.GIF>

Wheel motors:

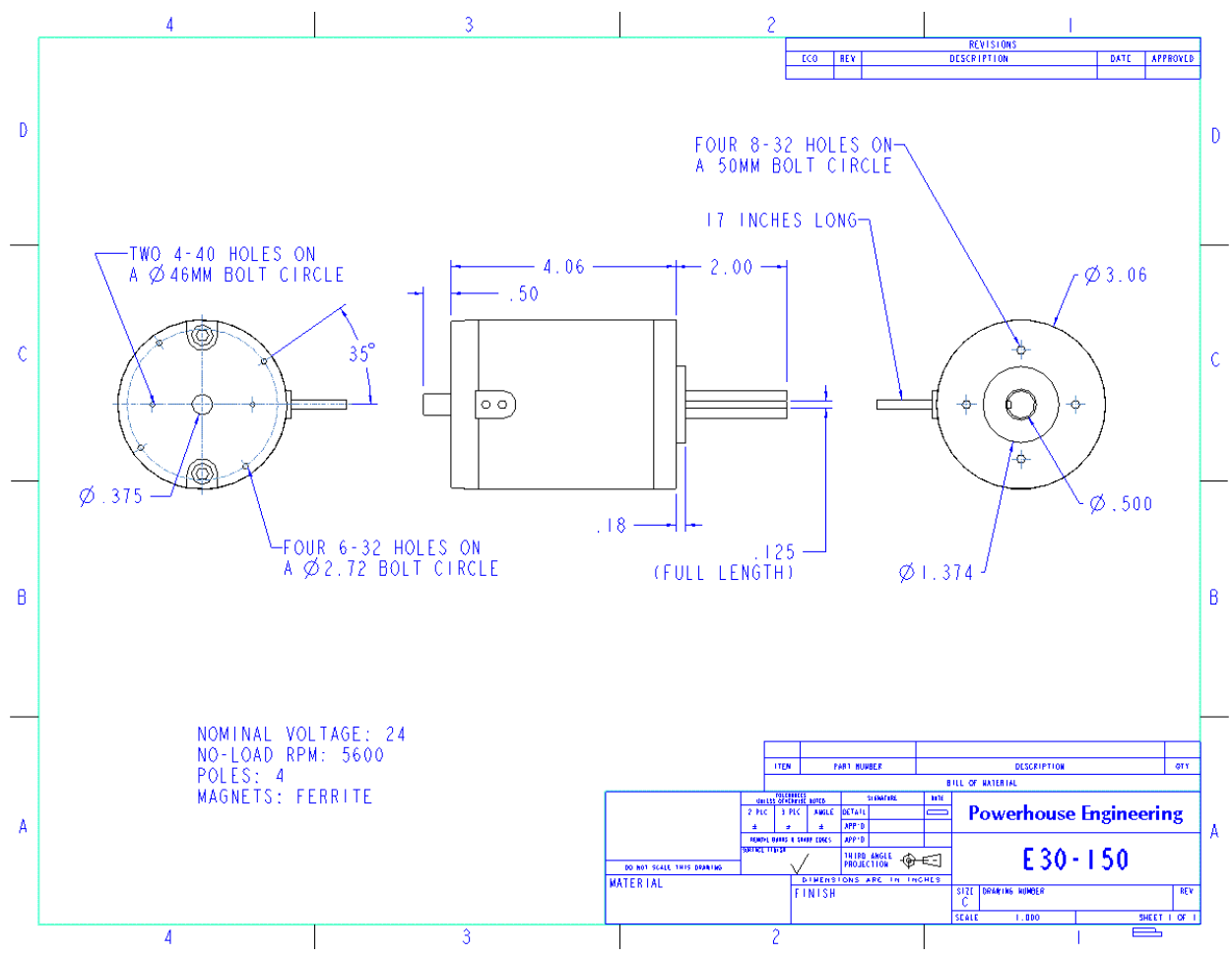

AmpFlow E30-150 12V Motor

<https://www.robotmarketplace.com/products/0-e30-150-12.html>

Journals:

 MIAMI UNIVERSITY REGIONAL LOCATIONS Hamilton · Middletown · West Chester		Meeting Journal Department of Engineering Technology ENT 497/498 - Senior Design Project Project Title: Shawnee Battlebot																	
<table border="1"> <tr> <td>Advisor: Reza Abrisham Baf</td> <td>Present</td> <td><input type="checkbox"/></td> </tr> <tr> <td>Student: Braden Bakenhaster</td> <td></td> <td><input checked="" type="checkbox"/></td> </tr> <tr> <td>Student: Nick Newton</td> <td></td> <td><input checked="" type="checkbox"/></td> </tr> <tr> <td>Student:</td> <td></td> <td><input type="checkbox"/></td> </tr> </table>		Advisor: Reza Abrisham Baf	Present	<input type="checkbox"/>	Student: Braden Bakenhaster		<input checked="" type="checkbox"/>	Student: Nick Newton		<input checked="" type="checkbox"/>	Student:		<input type="checkbox"/>	<table border="1"> <tr> <td>Meeting Date:</td> <td>8/27/20 and 9/7/20</td> </tr> <tr> <td>Meeting Location:</td> <td>Webex</td> </tr> </table>		Meeting Date:	8/27/20 and 9/7/20	Meeting Location:	Webex
Advisor: Reza Abrisham Baf	Present	<input type="checkbox"/>																	
Student: Braden Bakenhaster		<input checked="" type="checkbox"/>																	
Student: Nick Newton		<input checked="" type="checkbox"/>																	
Student:		<input type="checkbox"/>																	
Meeting Date:	8/27/20 and 9/7/20																		
Meeting Location:	Webex																		
<p>Topics Discussed</p> <p>The major topic discussed on 8/27/20 was the main idea for our project. We decided that we are going to build a battlebot for our project on 9/7/20. We then discussed different aspects of the bot. This included shape, weapons, drivetrain, and controls. We also discussed the rules that are required for the bot according to the Battlebots website. We decided that the shape of the bot will be a semicircle with a flat-faced front. We also decided that the "weapon" for our bot will be of the spinning variety. We discussed the need to do research especially on the remote-control system that will be</p>																			
<p>Responsibilities/ Actions Taken</p> <p>We decided that the battlebot would be our project. We decided that we need to do a great deal of research to make this project come to life. We are going to do research on possible remote-control options, motors, and batteries for the project. The plan is to see what is available for these three key components and design our robot to effectively function and house these parts. The actions taken, therefore, were deciding on the battlebot and doing more research. We are both responsible for researching possible remote-control, battery, and motor options at this point.</p>																			
Next Meeting Date:		9/3/2020	Location: Webex																

ENT 497 week 3

 MIAMI UNIVERSITY REGIONAL LOCATIONS Hamilton · Middletown · West Chester		Meeting Journal Department of Engineering Technology ENT 497/498 - Senior Design Project Project Title: Shawnee Battlebot																	
<table border="1"> <tr> <td>Advisor: Reza Abrisham Baf</td> <td>Present</td> <td><input type="checkbox"/></td> </tr> <tr> <td>Student: Braden Bakenhaster</td> <td></td> <td><input checked="" type="checkbox"/></td> </tr> <tr> <td>Student: Nick Newton</td> <td></td> <td><input checked="" type="checkbox"/></td> </tr> <tr> <td>Student:</td> <td></td> <td><input type="checkbox"/></td> </tr> </table>		Advisor: Reza Abrisham Baf	Present	<input type="checkbox"/>	Student: Braden Bakenhaster		<input checked="" type="checkbox"/>	Student: Nick Newton		<input checked="" type="checkbox"/>	Student:		<input type="checkbox"/>	<table border="1"> <tr> <td>Meeting Date:</td> <td>9/3/20 and 9/9/20</td> </tr> <tr> <td>Meeting Location:</td> <td>Webex</td> </tr> </table>		Meeting Date:	9/3/20 and 9/9/20	Meeting Location:	Webex
Advisor: Reza Abrisham Baf	Present	<input type="checkbox"/>																	
Student: Braden Bakenhaster		<input checked="" type="checkbox"/>																	
Student: Nick Newton		<input checked="" type="checkbox"/>																	
Student:		<input type="checkbox"/>																	
Meeting Date:	9/3/20 and 9/9/20																		
Meeting Location:	Webex																		
<p>Topics Discussed</p> <p>In the meetings on 9/3/20 and 9/9/20, our group discussed a few topics. We talked a great deal about the design of our battlebot. We made a decision on what type of battlebot we wanted to create. We decided on a battlebot with a spinning drum. We had a few rough sketches, and Nick created a better sketch. I then set up the Jira and typed in some of our roadmap while Nick and I discussed them. We also decided that after we get things a little more sorted out, we will try to discuss at least one different part per meeting, so we can start creating a parts list and budget.</p>																			
<p>Responsibilities/ Actions Taken</p> <p>The actions taken include the creating of the rough sketch, the creation of the Jira roadmap, and the discussion of future meetings. We also decided that we would meet again after class on Thursday to discuss.</p>																			
Next Meeting Date:		#####	Location: Webex																

ENT 497 week 4

 MIAMI UNIVERSITY REGIONAL LOCATIONS Hamilton · Middletown · West Chester		Meeting Journal Department of Engineering Technology ENT 497/498 - Senior Design Project Project Title: Battlebot																	
<table border="1"> <tr> <td>Advisor: Reza Abrisham Baf</td> <td>Present</td> <td><input type="checkbox"/></td> </tr> <tr> <td>Student: Braden Bakenhaster</td> <td></td> <td><input checked="" type="checkbox"/></td> </tr> <tr> <td>Student: Nick Newton</td> <td></td> <td><input checked="" type="checkbox"/></td> </tr> <tr> <td>Student:</td> <td></td> <td><input type="checkbox"/></td> </tr> </table>		Advisor: Reza Abrisham Baf	Present	<input type="checkbox"/>	Student: Braden Bakenhaster		<input checked="" type="checkbox"/>	Student: Nick Newton		<input checked="" type="checkbox"/>	Student:		<input type="checkbox"/>	<table border="1"> <tr> <td>Meeting Date:</td> <td>9/10/20 and 9/15/20</td> </tr> <tr> <td>Meeting Location:</td> <td>Webex</td> </tr> </table>		Meeting Date:	9/10/20 and 9/15/20	Meeting Location:	Webex
Advisor: Reza Abrisham Baf	Present	<input type="checkbox"/>																	
Student: Braden Bakenhaster		<input checked="" type="checkbox"/>																	
Student: Nick Newton		<input checked="" type="checkbox"/>																	
Student:		<input type="checkbox"/>																	
Meeting Date:	9/10/20 and 9/15/20																		
Meeting Location:	Webex																		
<p>Topics Discussed</p> <p>We discussed a few things in our meetings over the past week. Thursday, we discussed motors, wheels, and batteries. We searched the web and found wheel assemblies that include the motor, chains, and wheels that we believe will work well. We also found a motor for the spinning drum that we believe will work well. We then spent time looking for batteries for our Battlebot. We think that we have found a battery option that will work. In our meeting Tuesday, we discussed the structure of the bot. This included the layout, bracing, location for certain motors, materials, weight, and design strength. We also discussed the shape of our spinning drum. Nick designed a few spinner options in Fusion 360. We spent a good deal of time discussing bracing Tuesday because we were trying to see how much room we will have for internals, batteries, electrical, etc. We discussed the materials that we will need to decide on to keep our bot under the 250lb weight</p>																			
<p>Responsibilities/ Actions Taken</p> <p>We found wheels, motors, and batteries that we believe will work. We also picked a spinner design that we like. We made progress with our design and bracing for the bot. We also decided that Nick would work some more on the Fusion 360 design, and Braden would add to the Jira for our next meeting.</p>																			
Next Meeting Date:		9/17/2020	Location: Webex																

ENT 497 week 5

 MIAMI UNIVERSITY REGIONAL LOCATIONS Hamilton · Middletown · West Chester		Meeting Journal Department of Engineering Technology ENT 497/498 - Senior Design Project Project Title: Battlebot																	
<table border="1"> <tr> <td>Advisor: Reza Abrisham Baf</td> <td>Present</td> <td><input type="checkbox"/></td> </tr> <tr> <td>Student: Braden Bakenhaster</td> <td></td> <td><input checked="" type="checkbox"/></td> </tr> <tr> <td>Student: Nick Newton</td> <td></td> <td><input checked="" type="checkbox"/></td> </tr> <tr> <td>Student:</td> <td></td> <td><input type="checkbox"/></td> </tr> </table>		Advisor: Reza Abrisham Baf	Present	<input type="checkbox"/>	Student: Braden Bakenhaster		<input checked="" type="checkbox"/>	Student: Nick Newton		<input checked="" type="checkbox"/>	Student:		<input type="checkbox"/>	<table border="1"> <tr> <td>Meeting Date:</td> <td>9/16/20 and 9/22/20</td> </tr> <tr> <td>Meeting Location:</td> <td>Webex</td> </tr> </table>		Meeting Date:	9/16/20 and 9/22/20	Meeting Location:	Webex
Advisor: Reza Abrisham Baf	Present	<input type="checkbox"/>																	
Student: Braden Bakenhaster		<input checked="" type="checkbox"/>																	
Student: Nick Newton		<input checked="" type="checkbox"/>																	
Student:		<input type="checkbox"/>																	
Meeting Date:	9/16/20 and 9/22/20																		
Meeting Location:	Webex																		
<p>Topics Discussed</p> <p>We discussed the design of our battlebot over the past two meetings. We discussed how we are going to build the structure. We spent a great deal of time talking about the way we are going to create the interior bracing. This involves creating a space for the motors, electronics, and batteries. We also spent time discussing different material options that would affect our design. We are in a constant battle with weight due to the battlebot weight limit of 250lbs.</p>																			
<p>Responsibilities/ Actions Taken</p> <p>For this week, we are meeting after class on 9/24/20 to continue discussing the design, and hopefully begin to move on to discussing electronic components. We also have to work on the Jira and the 3D CAD models</p>																			
Next Meeting Date:		#####	Location: Webex																

ENT 497 week 6

MIAMI UNIVERSITY REGIONAL LOCATIONS Hamilton · Middletown · West Chester		Meeting Journal Department of Engineering Technology ENT 497498 - Senior Design Project Project Title: Battlebot	
Advisor Reza Abrisham Baf	Present		
Student Braden Bakenhaster	[Y]		
Student Nick Newton	[Y]		
Student:	[]	Meeting Date: 9/24/20 and 9/29/20	
Student:	[]	Meeting Location: Webex	
Topics Discussed			
This week was a busy one for our battlebot team. Nick completed our Fusion 360 file for the battlebot. We discussed the material components on Thursday. This include the necessary exterior and interior materials. We discussed the electrical components for the project on Tuesday. This involved the necessary RC components, controller, transmitter, electric speed control, switches, etc. We also constructed a parts list for the project. Braden edited the Jira for our timeline and added the necessary tasks. We also created a step by step plan for the project. Braden also worked on the proposal document.			
Responsibilities/ Actions Taken			
The actions taken were constructing a parts list, deciding on electrical components, finalizing our design, creating a timeline, and working on our proposal. The goal now is to finish up the rough draft so we can have Professor Reza look over all of the components, so we can make any necessary changes.			
Next Meeting Date: 10/1/2020		Location: Webex	

ENT 497 week 7

MIAMI UNIVERSITY REGIONAL LOCATIONS Hamilton · Middletown · West Chester		Meeting Journal Department of Engineering Technology ENT 497498 - Senior Design Project Project Title: Battlebot	
Advisor Reza Abrisham Baf	Present		
Student Braden Bakenhaster	[Y]		
Student Nicholas Newton	[Y]		
Student:	[]	Meeting Date: 10/1/20 and 10/6/20	
Student:	[]	Meeting Location: Webex	
Topics Discussed			
This week we worked on completing things to submit a rough draft proposal on Thursday 10/6/20, so we can spend the remaining week before the due date fixing any errors we may have. We worked on the Jira to make it better match the step by step process and added documents that were needed to make it more comprehensive. We worked on formatting our proposal document. We worked on the Fusion 360 design by adding the finishing touches such as the diamond plate armor, the spinner, and dimensions. We inserted the Fusion 360 design and electrical diagram into the proposal. We edited our budget and inserted it into our proposal. The goal for Thursday 10/6/20 is to have our rough draft and design looked over so we can make any necessary changes as soon as possible so we are ready before the 10/15/20 due date. The rough draft of our proposal is submitted in canvas with this Excel file.			
Responsibilities/ Actions Taken			
This upcoming week will involve adding to the proposal any needed information. It will also involve looking over our design again to ensure we are where we need to be on electrical, mechanical, and financial aspects, and our requirements are met.			
Next Meeting Date: 10/6/2020		Location: Webex	

ENT 497 week 8

MIAMI UNIVERSITY REGIONAL LOCATIONS Hamilton · Middletown · West Chester		Meeting Journal Department of Engineering Technology ENT 497498 - Senior Design Project Project Title: Battlebot	
Advisor Reza Abrisham Baf	Present		
Student Braden Bakenhaster	[Y]		
Student Nicholas Newton	[Y]		
Student:	[]	Meeting Date: 9/9/20 and 9/13/20	
Student:	[]	Meeting Location: Webex	
Topics Discussed			
This week, we focused on the proposal. We created a better electrical diagram using PowerPoint that more clearly displayed our project, and we had it looked over by Reza. It is displayed to the right. We edited our budget by switching out a type of screws for a cheaper type, and we added a section for "various other costs and shipping". We did a weight analysis chart for the proposal to ensure that the bot stays under the required 250lb limit. It is displayed to the right. We edited our Jira and added necessary documents in the correct sections. We discussed the need to contact Shawnee State so we can better plan our schedule for the frame construction of our bot. We contacted Shawnee State University to ensure we would have access to their machine shop. They said it should not be a problem, and they will contact us with a final answer as soon as the head of engineering signs off on it.			
Responsibilities/ Actions Taken			
The next step will be correcting any issues with the proposal. After the proposal is finalized, we will apply for the scholarship. We will then begin to order the components for the bot and begin frame construction when we obtain enough of the components.			
Next Meeting Date: 9/15/2020		Location: Webex	

ENT 497 week 9

Material/Object	Weight (lb)	Components
Aluminum 1/4"	51	1/4" side, back, and front pannel; 1/4" top and bottom plate; battery box
Aluminum 1" x 1" bar	4	Bracing
Diamond plate 1/8"	17.5	Outside armour
Spinner	15	3" round bar stock steel milled; 5/8" steel bar
Spinner mounts	3.5	Mounts 5/8" ID
Spinner motor	3.5	Magmotor, S28-F4-150X, 500280444, 24 VDC, Brushed Servo Motor, DC Electric Motor
Spinner chain and sprockets	1.5	1/4" chain; sprocket ID 1/2"; sprocket ID 5/8"
Wheel assemblies	17.5	Battlekit Single Drive Module A and B; E30 150 motor x2
caster wheels	0.5	2 caster wheels
Batteries	25.5	Mighty Max Battery 12V 12Ah F2 Razor Battery 1/5 128190003-3 Pack; 4 AA battery pack
Electrical components	1.5	Receiver, electrical speed control x2, remote on/off switch, wire, on/off switches, and connectors
nuts, bolts, welds, brackets, etc.	15	Bolts, nuts, washers, screws, welds, motor brackets, spinner mount brackets,
Total Estimate	156	Pounds

Note: This is a weight estimate. Weight will most likely be slightly more due to excess bracing being installed as needed

The electrical diagram shows a 24V Battery connected to a Remote Control On/Off Switch. The switch is connected to a Receiver. The Receiver is connected to a Transmitter. The Receiver is also connected to an Electric Speed Control Left, which is connected to a Left Wheel Motor 12V. The Receiver is connected to an Electric Speed Control Right, which is connected to a Right Wheel Motor 12V. The Receiver is connected to a 6V Battery. The Receiver is connected to an On/Off switch, which is connected to a 12V Battery.

A	B	C	D	E	F	G	H	I	J	L																
 MIAMI UNIVERSITY REGIONAL LOCATIONS Hamilton - Middletown - West Chester					Meeting Journal Department of Engineering Technology ENT 497498 - Senior Design Project Project Title: Battlebot																					
<table border="1"> <thead> <tr> <th></th> <th>Present</th> </tr> </thead> <tbody> <tr> <td>Advisor Reza Abrisham Baf</td> <td>[]</td> </tr> <tr> <td>Student Braden Bakerhaster</td> <td>[Y]</td> </tr> <tr> <td>Student Nicholas Newton</td> <td>[Y]</td> </tr> <tr> <td>Student:</td> <td>[]</td> </tr> <tr> <td>Student:</td> <td>[]</td> </tr> </tbody> </table>						Present	Advisor Reza Abrisham Baf	[]	Student Braden Bakerhaster	[Y]	Student Nicholas Newton	[Y]	Student:	[]	Student:	[]	<table border="1"> <tr> <td>Meeting Date:</td> <td>9/15/20 and 9/20/20</td> </tr> <tr> <td>Meeting Location:</td> <td>Webex</td> </tr> </table>						Meeting Date:	9/15/20 and 9/20/20	Meeting Location:	Webex
	Present																									
Advisor Reza Abrisham Baf	[]																									
Student Braden Bakerhaster	[Y]																									
Student Nicholas Newton	[Y]																									
Student:	[]																									
Student:	[]																									
Meeting Date:	9/15/20 and 9/20/20																									
Meeting Location:	Webex																									
<table border="1"> <thead> <tr> <th colspan="2">Topics Discussed</th> </tr> </thead> <tbody> <tr> <td colspan="2"> This week we focused on fixing our proposal and our electrical system. We made the needed adjustments to our proposal based on the given feedback. This included fixing the Jira, appendix, title page, and objective. We also decided to make the bot a 12V system. Prior to this, we had been looking at 12V motors for the wheels, a 24V motor for the spinner, and 6V to power the receiver. We changed our spinner motor to a 12V motor, and we added a 12V to 6V converter for our receiver. This motor adjustment dropped the price of the bot by \$200, and it allows us to run the three 12V batteries in parallel giving us a higher amp output. We updated our budget, weight analysis, and proposal motor diagrams for the updated 12V design. We also recreated our electrical diagram to work with the 12V system. The updated electrical diagram, budget, and weight analysis are pictured to the right. </td> </tr> </tbody> </table>											Topics Discussed		This week we focused on fixing our proposal and our electrical system. We made the needed adjustments to our proposal based on the given feedback. This included fixing the Jira, appendix, title page, and objective. We also decided to make the bot a 12V system. Prior to this, we had been looking at 12V motors for the wheels, a 24V motor for the spinner, and 6V to power the receiver. We changed our spinner motor to a 12V motor, and we added a 12V to 6V converter for our receiver. This motor adjustment dropped the price of the bot by \$200, and it allows us to run the three 12V batteries in parallel giving us a higher amp output. We updated our budget, weight analysis, and proposal motor diagrams for the updated 12V design. We also recreated our electrical diagram to work with the 12V system. The updated electrical diagram, budget, and weight analysis are pictured to the right.													
Topics Discussed																										
This week we focused on fixing our proposal and our electrical system. We made the needed adjustments to our proposal based on the given feedback. This included fixing the Jira, appendix, title page, and objective. We also decided to make the bot a 12V system. Prior to this, we had been looking at 12V motors for the wheels, a 24V motor for the spinner, and 6V to power the receiver. We changed our spinner motor to a 12V motor, and we added a 12V to 6V converter for our receiver. This motor adjustment dropped the price of the bot by \$200, and it allows us to run the three 12V batteries in parallel giving us a higher amp output. We updated our budget, weight analysis, and proposal motor diagrams for the updated 12V design. We also recreated our electrical diagram to work with the 12V system. The updated electrical diagram, budget, and weight analysis are pictured to the right.																										
<table border="1"> <thead> <tr> <th colspan="2">Responsibilities/ Actions Taken</th> </tr> </thead> <tbody> <tr> <td colspan="2"> Our next step will be getting final approval for our proposal. After we receive this approval, we will apply for the scholarship. We will then begin ordering materials for our bot. We will begin construction of the frame soon after the frame materials arrive. </td> </tr> </tbody> </table>											Responsibilities/ Actions Taken		Our next step will be getting final approval for our proposal. After we receive this approval, we will apply for the scholarship. We will then begin ordering materials for our bot. We will begin construction of the frame soon after the frame materials arrive.													
Responsibilities/ Actions Taken																										
Our next step will be getting final approval for our proposal. After we receive this approval, we will apply for the scholarship. We will then begin ordering materials for our bot. We will begin construction of the frame soon after the frame materials arrive.																										
Next Meeting Date:					9/22/2020		Location:				Webex															

ENT 497 week 10

Battlebot Budget Breakdown					
Part	Price	Number of Parts	Price for parts needed	Estimated Shipping	Store
Spinner motor	109	x1	109	28	Robot Market Place
Wheel motor left side A	260	x1	260	55	Robot Market Place
Wheel motor left side B	260	x1	260	0	Amazon
Batteries	70	x1	70	0	Amazon
Caster wheels	19	x1	19	0	Amazon
3" x 24" steel round stock	129.57	x1	129.57	45	online metals.com
5/8" x 6" steel round stock	51.15	x1	51.15	0	McMaster
Sprocket 5/8" ID #25	12.67	x1	12.67	0	McMaster
Sprocket 1/2" ID #25	12.42	x1	12.42	60	McMaster
Chain #25 1/4" pitch 6'	30.84	x1	30.84	0	McMaster
Chain link connector	1	x2	2	0	McMaster
Bearings 5/8" ID	16.7	x2	33.4	13	Gornger
Turnigy transmitter/receiver	56.19	x1	56.19	13	Hobby King
Receiver battery pack	8.28	x1	8.28	0	Amazon
Cable connectors	7.99	x1	7.99	0	Amazon
Remote on/off switch	8.24	x1	8.24	0	Hobby King
Electric speed control	44.99	x2	89.98	3	Horizon Hobby
On/off switches	7.65	x1	7.65	0	Amazon
10 gauge wire	15.48	x1	15.48	0	Amazon
12 gauge wire	9.95	x1	9.95	0	Amazon
Various connectors	18.99	x1	18.99	0	Amazon
Solder electrical and welding	40	x1	40	0	Amazon
7" x 3/8" bolt	1.25	x8	10	0	Lowes
Dowel pin 1/8" x 5/8" count	12.79	x1	12.79	0	McMaster
3/8" lock washers 25 count	4.2	x1	4.2	0	Home Depot
3/8" washers 25 count	3.98	x1	3.98	0	Home Depot
3/8" nut 25 count	3.56	x1	3.56	0	Home Depot
3/8" x 2.5" bolt 25 count	10.35	x1	10.35	0	Home Depot
#8 x 1/2 in. self tapping screws x240	7.21	x1	7.21	0	Home Depot
24" x 24" x 1/8" diamond plate	40	x1	40	20	Amazon
1/8" x 12" x 36" diamond plate	41.95	x2	83.9	0	Amazon
1/4" x 24" x 24" 6061 aluminum	88	x2	176	16	eBay
paint decals	30	x1	30	0	Amazon
angle metal (for brackets)	30	x1	30	0	Home Depot
1" x 1" x 6' Aluminum square stock	38.64	x1	38.64	34	Metals Depot
1/8" x 6" x 18" Aluminum 6061	14.2	x7	99.4	49	Amazon
Battery pack insulation	25	x1	25	0	Amazon
Battery mounting components	30	x1	30	0	Amazon
Various other components and shipping	316	x1	316	0	Amazon
Totals			\$2,164	\$336.00	
			Total Estimate	\$2,500	

Weight Analysis Estimate		
Material/Design	Weight (lb)	Comments
Aluminum 1/4"	51	1/4" side, back, and front panels, 1/4" top and bottom plate; battery box
Aluminum 1" x 1" bar	4	Bracing
Diamond plate 1/8"	17.5	Outside armor
Spinner	15	1/2" round bar stock steel milled, 5/8" steel bar
Spinner motor	3.5	Mounts 5/8" ID
Spinner chain and sprockets	6	Ampliflow F30-400 12V Motor 1.6hp
Wheel assemblies	17.5	1/4" chain, sprocket ID 1/2", sprocket ID 5/8"
caster wheels	0.5	Battlebot Single Drive Module A and B, E30 150 motor x2
Batteries	25.5	2 chadler wheels
Electrical components	1.5	Mighty Max Battery 12V 12Ah F2 Razor Battery W15S2810003-6 Pack; 4 AA battery pack
nuts, bolts, welds, brackets, etc.	15	Receiver, electrical speed control x2, remote on/off switch, wire, on/off switches, and connectors
Total Estimate	158.5	(lbs)

Note: This is a weight estimate. Weight will most likely be slightly more due to excess bracing being installed as needed.

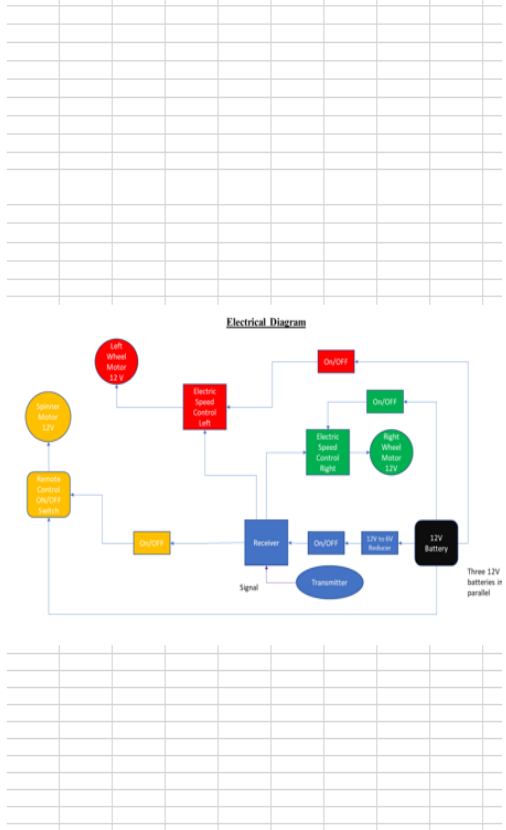



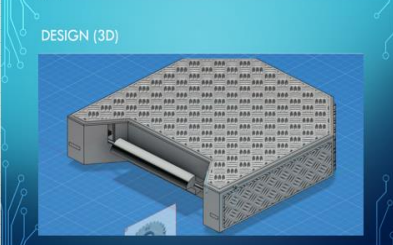

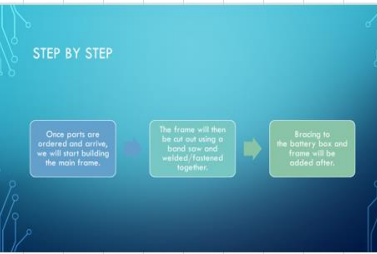

		Meeting Journal Department of Engineering Technology ENT 497498 - Senior Design Project Project Title: Battlebot											
<table border="1"> <tr> <td>Advisor Peza Abrisham Baf</td> <td>Present</td> </tr> <tr> <td>Student Braden Bakerhaster</td> <td>[Y]</td> </tr> <tr> <td>Student Nicholas Newton</td> <td>[Y]</td> </tr> <tr> <td>Student:</td> <td>[]</td> </tr> <tr> <td>Student:</td> <td>[]</td> </tr> </table>		Advisor Peza Abrisham Baf	Present	Student Braden Bakerhaster	[Y]	Student Nicholas Newton	[Y]	Student:	[]	Student:	[]	Meeting Date: 1/19/20 and 1/19/20 Meeting Location: Webex	
Advisor Peza Abrisham Baf	Present												
Student Braden Bakerhaster	[Y]												
Student Nicholas Newton	[Y]												
Student:	[]												
Student:	[]												
Topics Discussed This week we focused on creating our presentation. This was a good opportunity to go back through our proposal and put together the important aspects for the presentation. We also discussed ordering. When we receive the scholarship, we will begin creating the order forms needed. Presentation slides can be shown upon request. Examples to the side.													
Responsibilities/Actions Taken This week, we plan to work on our report, and begin ordering if possible.													
Next Meeting Date: 1/19/2020		Location: Webex											











ENT 497 week 13

		Meeting Journal Department of Engineering Technology ENT 497498 - Senior Design Project Project Title: Battlebot											
<table border="1"> <tr> <td>Advisor Peza Abrisham Baf</td> <td>Present</td> </tr> <tr> <td>Student Braden Bakerhaster</td> <td>[X]</td> </tr> <tr> <td>Student Nick Newton</td> <td>[X]</td> </tr> <tr> <td>Student:</td> <td>[]</td> </tr> <tr> <td>Student:</td> <td>[]</td> </tr> </table>		Advisor Peza Abrisham Baf	Present	Student Braden Bakerhaster	[X]	Student Nick Newton	[X]	Student:	[]	Student:	[]	Meeting Date: 1/20/20 and 1/21/20 Meeting Location: Workshop	
Advisor Peza Abrisham Baf	Present												
Student Braden Bakerhaster	[X]												
Student Nick Newton	[X]												
Student:	[]												
Student:	[]												
Topics Discussed Recap of Webex completed since the end of ENT 497: We had one or two Webex meetings before Christmas to discuss delivery and order of parts. Thursday January 7th: We had a Webex meeting and discussed part deliveries. Monday January 11th: We had a Webex meeting and discussed part deliveries. We discussed what parts had been received. We setup a time to meet up and look over our parts at the workshop. Wednesday January 13th: We met at the workshop and looked over the parts we had received. We made a rough layout of the parts we had. We discussed the tools and parts needed to get started on the building in the next meeting. Friday January 15th: We began construction of the battlebot. We did a layout on the bottom plate. We decided to make the front angle side cutout 5 1/2 inches instead of 5 inches to ensure plenty of room for the spinner. The 2"x2"x0.25" aluminum bottom plate was cut to the correct shape using a jigsaw and angle grinder. The edges were knocked off using sandpaper. The 6"x0.25" aluminum middle front side plate was cut with a bandsaw and welded into place. Monday January 18th: The rest of the front side plates were cut using a bandsaw and welded into place. The welding process takes time because we have to heat the aluminum with a torch due to the colder temperatures of our workshop. Friday January 22nd: The rest of the side pieces were cut with the bandsaw and welded into place. The battery box was laid out. The battery box was then built using the 6"x0.25" Aluminum and welded into place. Monday January 25th: Began work on mounting right-side wheel assembly. Laidout where wheel will sit. Disassembled wheel assembly, took measurements and drilled mounting holes in assembly and side of bot. Cut zims for the wheel assembly. Friday January 29th: Cut hole for wheel. Reassembled and mounted wheel assembly via 2" bolts. Monday February 1st: Completed the mounting process for the left wheel assembly the same way as the right side listed above. Meeting stopped early due to snow causing poor road conditions.													
Responsibilities/Actions Taken This week, we plan to finish up some welding that needs to be done. We also plan to begin working on the spinner mounts and the spinner motor mount. We will then begin adding bracing where it is needed to add strength to our bot. We will cut the top plate to shape if we have time. We will be meeting on Friday and Monday before the next Thursday meeting.													
Next Meeting Date: 2/5/2021		Location: Workshop											

ENT 498 week 2

	Present
Advisor: Reza Abrisham Baf	<input type="checkbox"/>
Student: Braden Bakenhaster	<input checked="" type="checkbox"/>
Student: Nick Newton	<input checked="" type="checkbox"/>
Student:	<input type="checkbox"/>
Student:	<input type="checkbox"/>

Meeting Date:	2/5/21 and 2/8/21
Meeting Location:	Workshop

Topics Discussed

We worked on our project Friday 2/5/21 and 2/8/21. On Friday, we finished welding the frame. We also built shims for the spinner mounts. These were made out of 1/4 inch aluminum. We used three shims staked to raise the mounts 3/4 inch off the bottom of the bot floor. After cutting the shims, we drilled holes in the shims and the bottom of the bot to mount the spinner mounts. The mounts were attached via 2.5" bolts. We started working on the spinner motor mount. On Friday, we worked on the spinner motor mount. It was built from 5/16" x 5" x 3" angle iron. It was drilled to fit, and the motor was mounted via 8-32 x 3/4" allen head bolts. We also worked on aligning the spinner mounts and rod.

Responsibilities/ Actions Taken

This week, we hope to work on mounting the spinner motor to the bot, adding bracing, and the spinner. We hope to be able to mill our spinner out at Shawnee State's machine shop soon. We will be contacting them this week.

Next Meeting Date:	2/12/2021	Location:	Workshop
--------------------	-----------	-----------	----------

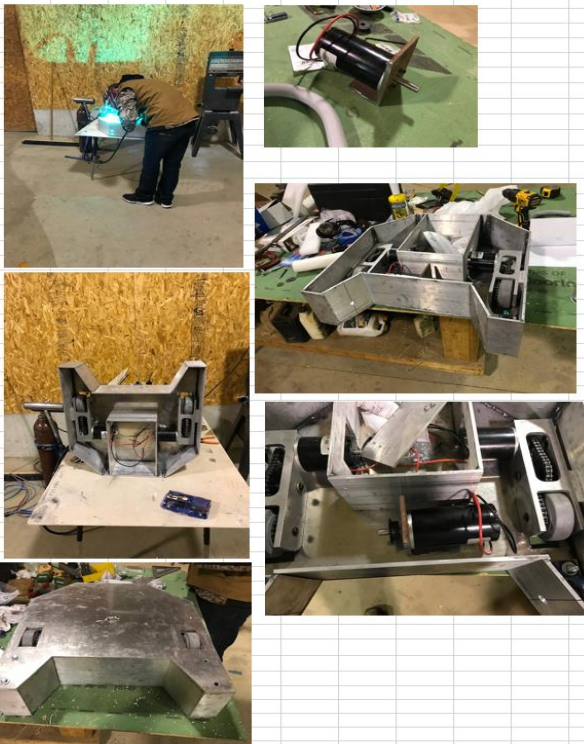

ENT 498 week 3

	Present
Advisor: Reza Abrisham Baf	<input type="checkbox"/>
Student: Braden Bakenhaster	<input checked="" type="checkbox"/>
Student: Nick Newton	<input checked="" type="checkbox"/>
Student:	<input type="checkbox"/>
Student:	<input type="checkbox"/>

Meeting Date:	2/12/21 and 2/17/21
Meeting Location:	Workshop

Topics Discussed

On Friday February 12th, we worked on laying out the milling of the spinner and gathered all of the other parts we wanted to take with us to mill. We were supposed to use the Shawnee machine shop on 2/15/21, but Shawnee State was closed due to the inclement weather. We moved our Monday meeting to Wednesday and are working on rescheduling our machining day. On Wednesday 2/17/21, we worked on building interior bracing and fitting the spinner. Braden worked on cutting and installing the bracing made from 1.8"x1"x1" aluminum angle stock. Nick worked on fitting the spinner using a piece of 5.8" round stock steel.

Responsibilities/ Actions Taken

Goal is to focus on finishing construction and spinner tasks. Hopefully we will be able to go to the machine shop next week. We are hoping to be done with the frame by the end of February and be able to move on to the electrical the beginning of March.

Next Meeting Date:	2/18/2021	Location:	Workshop
--------------------	-----------	-----------	----------



ENT 498 week 4



Meeting Journal
 Department of Engineering Technology
 ENT 497498 - Senior Design Project
 Project Title: Battlebot

	Present
Advisor Reza Abrisham Baf	<input type="checkbox"/>
Student Braden Bakenhaster	<input checked="" type="checkbox"/>
Student Nick Newton	<input checked="" type="checkbox"/>
Student:	<input type="checkbox"/>
Student:	<input type="checkbox"/>

Meeting Date: 2/19/21, 2/22/21, 2/24/21
Meeting Location: Workshop and Shawnee State University

Topics Discussed

On 2/19/21, we worked on fitting our spinner rod, and we worked on cutting and building the bracing. We cut the bracing out of 1"x1"x1/8" aluminum L bracket and 1"x1" aluminum bar stock. We used bolts to attach the bracing. We used drill bits, a jig saw, and a file to cut the opening for the spinner rod. On 2/22/21, we went to Shawnee to machine the spinner and the spinner motor mount. We had some help from the professor over the machine lab. The motor mount was milled. The spinner was spot drilled on both ends, but we had to get a 5/8" drill bit to drill the holes to mount the spinner rod. (Shawnee usually has all of the bits and mill parts you could ask for, but they didn't have a 5/8" drill bit because someone had taken it.) On 2/24/21, we went back to Shawnee, and we drilled the spinner on the lathe and milled the spinner using the CNC machine.

Responsibilities/ Actions Taken

This upcoming week we hope to finish the frame construction, mount the spinner, and begin the electrical.

Next Meeting Date: 2/26/2021 **Location:** Workshop

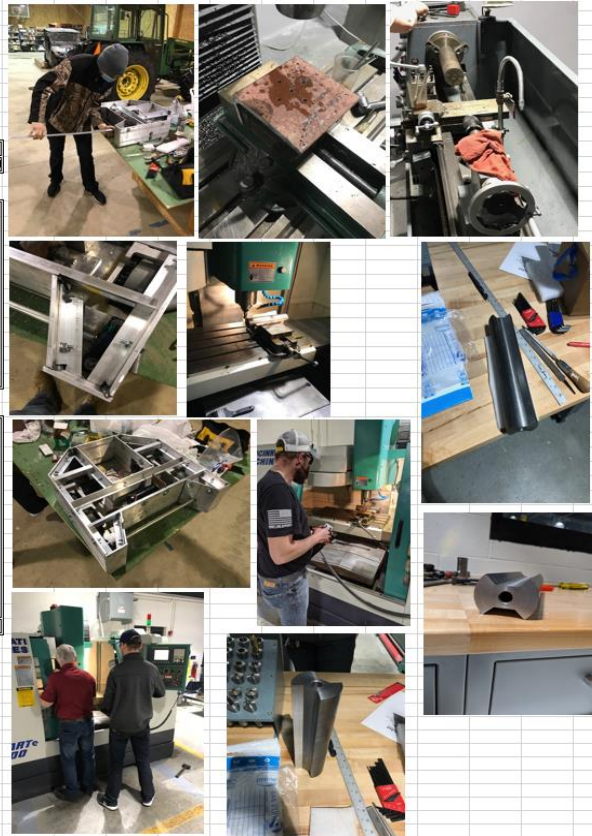

ENT 498 week 5



Meeting Journal
 Department of Engineering Technology
 ENT 497498 - Senior Design Project
 Project Title: Battlebot

	Present
Advisor Reza Abrisham Baf	<input type="checkbox"/>
Student Braden Bakenhaster	<input checked="" type="checkbox"/>
Student Nick Newton	<input checked="" type="checkbox"/>
Student:	<input type="checkbox"/>
Student:	<input type="checkbox"/>

Meeting Date: 2/26/21, 3/1/21, 3/3/21
Meeting Location: Workshop

Topics Discussed

On Friday, 2/26/21, we finished building the spinner by connecting the 5/8" rods to the milled spinner. We then connected the sprocket to the spinner. The spinner was then mounted to the bot frame by the spinner mounts which were installed in previous weeks. The spinner was centered and tightened down. We also began welding the bracing in place that we had built. On Monday, 3/1/21, we finished the necessary cutting on the spinner motor mount. The spinner motor was mounted to the mount. The mount was then connected to the floor of the bot via bolts. The spinner motor sprocket was lined up with the spinner sprocket and holes were drilled for the chain. The bracing welds were finished. The bracing was built so that it can be removed in one large piece to allow easy access to the internal components of the bot. On Wednesday, 3/3/21, we connected the chain to the spinner and motor. We tightened it and built a tensioner for it. We also designed our rear wheel assemblies. We then started on the electrical. We tested

Responsibilities/ Actions Taken

This week, we plan to build the rear wheel assemblies and continue work on the electrical system.



Next Meeting Date: 3/9/2021 **Location:** Workshop



ENT 498 week 6

 MIAMI UNIVERSITY REGIONAL LOCATIONS Hamilton · Middletown · West Chester		Meeting Journal Department of Engineering Technology ENT 497/498 - Senior Design Project Project Title: Battlebot																	
<table border="1"> <thead> <tr> <th></th> <th>Present</th> </tr> </thead> <tbody> <tr> <td>Advisor: Reza Abrisham Baf</td> <td>[]</td> </tr> <tr> <td>Student: Braden Bakenhaster</td> <td>[X]</td> </tr> <tr> <td>Student: Nick Newton</td> <td>[X]</td> </tr> <tr> <td>Student:</td> <td>[]</td> </tr> <tr> <td>Student:</td> <td>[]</td> </tr> </tbody> </table>			Present	Advisor: Reza Abrisham Baf	[]	Student: Braden Bakenhaster	[X]	Student: Nick Newton	[X]	Student:	[]	Student:	[]	<table border="1"> <tr> <td>Meeting Date:</td> <td>3/9/21, 3/17/21, 3/30/21, 3/30/21</td> </tr> <tr> <td>Meeting Location:</td> <td>Workshop</td> </tr> </table>		Meeting Date:	3/9/21, 3/17/21, 3/30/21, 3/30/21	Meeting Location:	Workshop
	Present																		
Advisor: Reza Abrisham Baf	[]																		
Student: Braden Bakenhaster	[X]																		
Student: Nick Newton	[X]																		
Student:	[]																		
Student:	[]																		
Meeting Date:	3/9/21, 3/17/21, 3/30/21, 3/30/21																		
Meeting Location:	Workshop																		
<p>Topics Discussed</p> <p>This week, we finished building our frame. We built both rear wheel assemblies. These assemblies are composed of bolt on mounts and caster wheels. They were built to be easily adjusted to set the desired height of the rear of the battlebot. We began working on the electrical system this week. We built the battery leads, and we wired up our on/off switches for the spinner, wheels, and all power. We worked on figuring out our motor controllers. This involved a good bit of reading from the manual. We also worked on programming and configuring the PIC receiver and transmitter.</p>																			
<p>Responsibilities/ Actions Taken</p> <p>This week, we will continue working on our electrical system. We hope to finish the electrical system and start on the exterior armor and top plate. After these tasks are completed, we will begin testing and recording results and do any necessary calculations.</p>																			
<table border="1"> <tr> <td>Next Meeting Date:</td> <td>3/12/2021</td> <td>Location:</td> <td>Workshop</td> </tr> </table>		Next Meeting Date:	3/12/2021	Location:	Workshop														
Next Meeting Date:	3/12/2021	Location:	Workshop																

ENT 498 week 7

 MIAMI UNIVERSITY REGIONAL LOCATIONS Hamilton · Middletown · West Chester		Meeting Journal Department of Engineering Technology ENT 497/498 - Senior Design Project Project Title: Battlebot																	
<table border="1"> <thead> <tr> <th></th> <th>Present</th> </tr> </thead> <tbody> <tr> <td>Advisor: Reza Abrishambaf</td> <td>[]</td> </tr> <tr> <td>Student: Braden Bakenhaster</td> <td>[X]</td> </tr> <tr> <td>Student: Nick Newton</td> <td>[X]</td> </tr> <tr> <td>Student:</td> <td>[]</td> </tr> <tr> <td>Student:</td> <td>[]</td> </tr> </tbody> </table>			Present	Advisor: Reza Abrishambaf	[]	Student: Braden Bakenhaster	[X]	Student: Nick Newton	[X]	Student:	[]	Student:	[]	<table border="1"> <tr> <td>Meeting Date:</td> <td>3/15/21 and 3/17/21</td> </tr> <tr> <td>Meeting Location:</td> <td>Workshop</td> </tr> </table>		Meeting Date:	3/15/21 and 3/17/21	Meeting Location:	Workshop
	Present																		
Advisor: Reza Abrishambaf	[]																		
Student: Braden Bakenhaster	[X]																		
Student: Nick Newton	[X]																		
Student:	[]																		
Student:	[]																		
Meeting Date:	3/15/21 and 3/17/21																		
Meeting Location:	Workshop																		
<p>Topics Discussed</p> <p>This week, we worked on the electrical components of the battlebot. We wired up our electrical components. This included the power switches, motor controllers, RC on/off switch, motors, on/off switches, and battery. We also set up the RC receiver and transmitter. The motor controllers were setup via a part specific software. The wheel motors are functioning well with the motor controllers and the RC controller and transmitter. The RC controlled on/off switch we have will not work with the spinner motor, and we have another part ordered to take its place. We believe the part is not rated for 12V. The switch came with no paper work. We ordered another switch that is the same brand as the RC transmitter and receiver (Turnigy), and we ordered a RC controlled relay rated for 12V and 20Amps. We believe that one of these will fix our problem.</p>																			
<p>Responsibilities/ Actions Taken</p> <p>This week, we hope to get our needed spinner control parts and finish our electrical system. We also plan to work on the top plate and install the diamond plate armor. We also have to switch out a few bolts to low profile bolts for ground clearance.</p>																			
<table border="1"> <tr> <td>Next Meeting Date:</td> <td>3/19/2021</td> <td>Location:</td> <td>Workshop</td> </tr> </table>		Next Meeting Date:	3/19/2021	Location:	Workshop														
Next Meeting Date:	3/19/2021	Location:	Workshop																

ENT 498 week 8

M MIAMI UNIVERSITY
REGIONAL LOCATIONS
Hamilton · Middletown · West Chester

Meeting Journal
Department of Engineering Technology
ENT 497/498 - Senior Design Project
Project Title: Battlebot

	Present
Advisor: Reza Abrishambaf	[]
Student: Braden Bakenhaster	[X]
Student: Nick Newton	[X]
Student:	[]
Student:	[]

Meeting Date: 3/19; 3/22; 3/24; 3/25
Meeting Location: Workshop

Topics Discussed

This week, we have been working on getting the spinner of our bot working. Our original RC controlled electronic on/off switch was not rated for the correct amount of volts. We replaced it with another switch and a relay, however, the new RC on/off switch was rated for 30V according to the literature, but it would only put out 5v. We needed 12V to activate our relay. We have another RC controlled relay that is supposed to arrive Friday for install. We also worked on the exterior armor of our bot. We cut all of the diamond plate to fit the sides of our bot and began drilling the mounting holes. We also changed our four switch system to a three switch system.

Responsibilities/ Actions Taken

This week, we hope to get our spinner electrical issues figured out and running effectively. We are also taking our spinner to SSU Monday to mill it down a little bit to cut down on the weight to reduce strain on the motor. We also hope to complete the work on the exterior of the battlebot.

Next Meeting Date: 3/26/2021 Location: Workshop



ENT 498 week 9

M MIAMI UNIVERSITY
REGIONAL LOCATIONS
Hamilton · Middletown · West Chester

Meeting Journal
Department of Engineering Technology
ENT 497/498 - Senior Design Project
Project Title: Battlebot

	Present
Advisor: Reza Abrisham Baf	[]
Student: Braden Bakenhaster	[X]
Student: Nick Newton	[X]
Student:	[]
Student:	[]

Meeting Date: 3/26/21; 3/29/21; 3/31/21
Meeting Location: Workshop

Topics Discussed

On 3/26/21, we worked on the electrical system for the spinner. We had been having trouble with electronic on/off switches. We ended up using an RC controlled relay rated for 20amps to power a 70amp relay that powered the spinner. The spinner was taking between 40 and 50 amps to cold start directly to full speed. We got the spinner working this way. We also worked on the armor for the bot. We currently have the bot stripped of the wheels and spinner for this installation. On 3/29/21, we took the spinner to Shawnee and did some milling on it to reduce the weight to reduce the strain on the spinner motor. Three pounds of material was milled off of the spinner (15lbs to 12lbs), and it is shown below. On 3/31/21, we programmed and installed an esc to control the spinner motor. We decided that an esc would be a better route for spinner control. It will allow us to start the spinner slower thus being easier on the motor. We also installed higher amp rated on/off switches. We worked on drilling the holes to mount the armor. We also painted our battlebot.

Responsibilities/ Actions Taken

This week we plan to complete the battlebot. Now that the bot is painted and the armor is cut and drilled, we plan to reassemble the bot. We had to move some wiring around and tidy up the inside. We also have to mount the top plate and secure the battery. We hope to finish all of this up by this weekend (April 3rd). We will then begin working on data collection from the bot and the presentation, slide show, and poster.

Next Meeting Date: 4/1/2021 Location: Workshop



ENT 498 week 10

 MIAMI UNIVERSITY <small>REGIONAL LOCATIONS</small> <small>Hamilton · Middletown · West Chester</small>		Meeting Journal Department of Engineering Technology ENT 497/498 - Senior Design Project Project Title: Battlebot													
<table border="1"> <thead> <tr> <th>Advisor:</th> <th>Present</th> </tr> </thead> <tbody> <tr> <td>Reza Abrisham Baf</td> <td>[]</td> </tr> <tr> <td>Student: Braden Bakenhaster</td> <td>[X]</td> </tr> <tr> <td>Student: Nick Newton</td> <td>[X]</td> </tr> <tr> <td>Student:</td> <td>[]</td> </tr> <tr> <td>Student:</td> <td>[]</td> </tr> </tbody> </table>	Advisor:	Present	Reza Abrisham Baf	[]	Student: Braden Bakenhaster	[X]	Student: Nick Newton	[X]	Student:	[]	Student:	[]	Meeting Date: 4/1/21; 4/2/21; 4/3/21; 4/5/21; 4/7/21 Meeting Location: workshop		
Advisor:	Present														
Reza Abrisham Baf	[]														
Student: Braden Bakenhaster	[X]														
Student: Nick Newton	[X]														
Student:	[]														
Student:	[]														
Topics Discussed Over the past week, we have completed the construction of our bot. We completed the necessary wiring, we drilled out the chain holes, we cut and painted the top plates, we bolted the wheels back on, we remounted our spinner, we adjusted the rear wheels, we built the battery mount, and we drilled and mounted the top plates. We then tested our battlebot to find any problems. We found that we had two bolts in the front of our bot that dragged the ground. These bolts were replaced with lower profile bolts which fixed the problem. We also had an issue with our ESCs that we are using for the bot. The ESCs worked, but the contacts were only rated for 15A. This made very rapid movements impossible. We decided to replace these ESCs with the same type ESC used in controlling the spinner motor. This fixed the problem and allows our bot to make very rapid movements. The construction on our bot is complete. We took some measurements on the RPM of the spinner. We received readings of 8300, 8500, 10700, and 12000 RPM.															
Responsibilities/ Actions Taken The focus this week is completing our slide show, presentation, and poster. We have to take a few more measurements from the bot to do the needed calculation for our paper work.															
Next Meeting Date:		4/8/2021		Location: webex											



ENT 498 week 11

 MIAMI UNIVERSITY <small>REGIONAL LOCATIONS</small> <small>Hamilton · Middletown · West Chester</small>		Meeting Journal Department of Engineering Technology ENT 497/498 - Senior Design Project Project Title: Battlebot													
<table border="1"> <thead> <tr> <th>Advisor:</th> <th>Present</th> </tr> </thead> <tbody> <tr> <td>Reza Abrisham Baf</td> <td>[]</td> </tr> <tr> <td>Student: Braden Bakenhaster</td> <td>[X]</td> </tr> <tr> <td>Student: Nick Newton</td> <td>[X]</td> </tr> <tr> <td>Student:</td> <td>[]</td> </tr> <tr> <td>Student:</td> <td>[]</td> </tr> </tbody> </table>	Advisor:	Present	Reza Abrisham Baf	[]	Student: Braden Bakenhaster	[X]	Student: Nick Newton	[X]	Student:	[]	Student:	[]	Meeting Date: 4/8; 4/9; 4/10; 4/11; 4/12; 4/13; 4/14 Meeting Location: Workshop and Webex		
Advisor:	Present														
Reza Abrisham Baf	[]														
Student: Braden Bakenhaster	[X]														
Student: Nick Newton	[X]														
Student:	[]														
Student:	[]														
Topics Discussed This week, we tested our bot. We took measurements of starting current for wheel motors and spinner motor. We took speed tests. We took spinner rpm measurements. We took battery life measurements. We took the weight. We also took photos and videos of the bot. We worked on our presentation and poster. We worked on figuring the total cost.															
Responsibilities/ Actions Taken This week, we plan to correct our slideshow as needed. We plan to record our presentation. We plan to complete our poster. We also plan to work on our final report.															
Next Meeting Date:		4/15/2021		Location: webex											

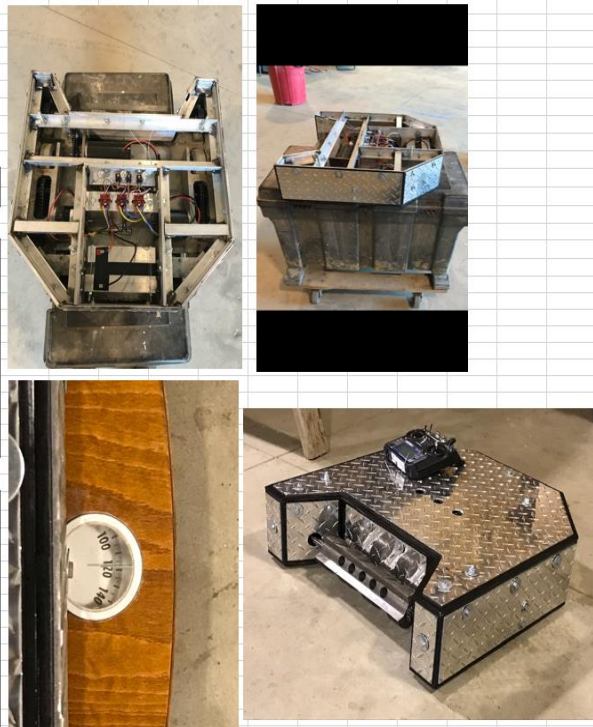

ENT 498 week 12

 MIAMI UNIVERSITY REGIONAL LOCATIONS Hamilton • Middletown • West Chester	Meeting Journal Department of Engineering Technology ENT 497/498 - Senior Design Project Project Title: Battlebot																
<table border="1"><tr><td>Advisor: Reza Abrisham Baf</td><td>Present</td></tr><tr><td></td><td>[]</td></tr><tr><td>Student: Braden Bakenhaster</td><td>[X]</td></tr><tr><td>Student: Nick Newton</td><td>[X]</td></tr><tr><td>Student:</td><td>[]</td></tr><tr><td>Student:</td><td>[]</td></tr></table>	Advisor: Reza Abrisham Baf	Present		[]	Student: Braden Bakenhaster	[X]	Student: Nick Newton	[X]	Student:	[]	Student:	[]	<table border="1"><tr><td>Meeting Date:</td><td>4/15; 4/17; 4/21</td></tr><tr><td>Meeting Location:</td><td>Webex</td></tr></table>	Meeting Date:	4/15; 4/17; 4/21	Meeting Location:	Webex
Advisor: Reza Abrisham Baf	Present																
	[]																
Student: Braden Bakenhaster	[X]																
Student: Nick Newton	[X]																
Student:	[]																
Student:	[]																
Meeting Date:	4/15; 4/17; 4/21																
Meeting Location:	Webex																
<table border="1"><tr><td>Topics Discussed</td></tr><tr><td>This week we worked on the paperwork and presentation. On Thursday April 15th, we completed our poster. We also made edits to our slideshow on the 15th. On Saturday April 17th, we recorded our presentation. On Wednesday April 21st, we worked on our final report. We also went through some information to prepare for the 2 minute presentation practice.</td></tr></table>		Topics Discussed	This week we worked on the paperwork and presentation. On Thursday April 15th, we completed our poster. We also made edits to our slideshow on the 15th. On Saturday April 17th, we recorded our presentation. On Wednesday April 21st, we worked on our final report. We also went through some information to prepare for the 2 minute presentation practice.														
Topics Discussed																	
This week we worked on the paperwork and presentation. On Thursday April 15th, we completed our poster. We also made edits to our slideshow on the 15th. On Saturday April 17th, we recorded our presentation. On Wednesday April 21st, we worked on our final report. We also went through some information to prepare for the 2 minute presentation practice.																	
<table border="1"><tr><td>Responsibilities/ Actions Taken</td></tr><tr><td>This week, we are focused on our final report and the 2 minute presentation on senior design day.</td></tr></table>		Responsibilities/ Actions Taken	This week, we are focused on our final report and the 2 minute presentation on senior design day.														
Responsibilities/ Actions Taken																	
This week, we are focused on our final report and the 2 minute presentation on senior design day.																	
Next Meeting Date:	4/22/2021																
Location:	Webex																

ENT 498 week 13

Proposal:

1

Battlebot

**Senior Design
Miami University
ENT 497 and ENT 498
Braden Bakenhaster and Nicholas Newton
Advisor: Reza Abrisham Baf**

2

Table of Contents

<u>Title, Team Members, Advisor, and Objective</u>	<u>Pg. 3</u>
<u>Justification and Applicability</u>	<u>Pg. 4</u>
<u>Step by Step Plan</u>	<u>Pg. 5</u>
<u>Timeline</u>	<u>Pg. 8</u>
<u>Cost</u>	<u>Pg. 10</u>
<u>Weight Analysis</u>	<u>Pg. 11</u>
<u>Final Comments</u>	<u>Pg. 11</u>
<u>Appendix</u>	<u>Pg. 12</u>
• <u>Front View</u>	<u>Pg. 12</u>
• <u>Back View</u>	<u>Pg. 13</u>
• <u>Dimensions</u>	<u>Pg. 14</u>
• <u>Electrical</u>	<u>Pg. 15</u>
• <u>Motors</u>	<u>Pg. 16</u>

3

Title:

Battlebot

Team Members:

Braden Bakenhaster and Nicholas Newton

Advisors Name:

Reza Abrisham Baf

Advisor's Signature:

Date:

Supporting Company:

No Supporting Company

Objective:

Battlebots are something that have been popular to niche crowds over the past two decades. The show *Battlebots* first aired in the year 2000 and is still creating new episodes today. There are other similar robot fighting shows that have also been aired including *Robot Wars*, and battlebots have made other pop culture appearances such as in an episode of *The Big Bang Theory*. The battlebot arena has harbored many designs over the years. In our battlebot design, we have tried to draw from those designs to create our own bot that is designed to be effective, and affordable with reference to other bots in its class. We are going to construct a battlebot with a custom-built spinning weapon mechanism that will be able to compete at a high level against other battlebots within an acceptable budget. The battlebot will be built within the guidelines presented by the official Battlebot rules. The bot must be under 250 pounds, less than 8' x 8' in size, have the necessary safety required on/off switches, and the power supply will be under 60 volts.

4

Justification and Applicability:

The justification for building this bot has a few parts. The first justification of building this bot is the design. The spinning weapon bots have had great success in the battlebots arena over the past few years. The next justification is the price. The design that we have developed is relatively low priced compared to other bots in the arena, and we believe that despite this lower price, it will still be effective. The last justification is the application of the project in terms of the ENT 497/498 class. This project meshes electrical and mechanical components very well. It presents a creative challenge to build due to its uniqueness.

Step by Step Plan:

- Research
 - Study rules for creating a battlebot
 - Define limitations and necessary components
 - Study what others are using in the battlebot competition
- Create design
 - Create 3d model via Fusion 360
 - Create specs page for the design
- Create components list
- Create Ghant chart with timeline and tasks
- Create projected cost list
- Obtain proposal approval
- Order frame components
 - Aluminum stock
 - Sheet Metal
 - Diamond Plate
 - Angle metal
 - Fasteners (bolts, nuts, washers, screws, etc.)
- Order motor and wheel components
 - Wheel and motor kits
 - Weapon motor
- Order spinner components
 - Steel stock
 - Pins
 - Sprockets
 - Mounts
- Build and shape bottom plate
 - Cut to desired shape from 2' x 2' x 0.25" Aluminum
 - Drill necessary bolt holes
 - Sand edges as needed

- Build side plates
 - Cut to desired length from 6" x 18" x 0.25" Aluminum
 - Mount to bottom plate
 - Mount via welding and brackets
- Build Interior Bracing
 - To be built from 6" x 0.25" and 1" x 1" Aluminum
 - Cut to fit
 - Mounted to bottom plate and side walls
 - Mounted via welding and brackets
 - Battery box walls built
 - Mounted via welding and brackets
- Mount wheel assemblies
 - Mount to frame via bolts
 - Brackets maybe necessary
 - Mount rear caster wheel
- Spinner mounts
 - 0.25" Aluminum to be used to build up from bottom plate to desired height
 - Pillow block bearing, ball bearings 5/8" ID mounted on both sides of the front of the bot via bolts
- Construct spinner
 - Mill spinner to desired shape
 - Heat treat spinner
 - Weld and pin spinner to mounting rod
 - Mount sprockets to spinner motor and spinner rod
 - Mount spinner to bot via bearings
- Assemble electrical components
 - Wire power switches
 - One for all power
 - One for each wheel
 - One for spinner only
 - Wire-up motors for wheels
 - Wire electrical speed control components
 - Connect wheel motors and battery
 - Wire-up motor for spinner
 - Wire remote controller on/off switch
 - Connect to battery and motor

- Connect RC receiver
 - Wire to low voltage battery pack
 - Connect to electric speed controls and remote on/off switch
- Program remote control
- Connect batteries to check function
- Complete remaining metal work
 - Build spinner motor mounts out of angle iron
 - Mount spinner motor brackets to motor and bottom plate
 - Cut and form top plate from 0.25" Aluminum sheet metal
 - Mount batteries and pad the battery box
 - Mount top plate
 - Mounted via bolts
 - Mount diamond plate to outside of bot
 - Mounted via-self tapping screws
- Finishing and testing
 - Check all screws and bolts are tight
 - Add any additional needed fasteners
 - Ensure rigidity of structure
 - Attach chain to spinner motor and spinner
 - Test function of remote control
 - Test function of wheel assemblies
 - Test function of spinner
 - Check structure after tests
 - Paint desired surfaces
 - Add any desired decals
- Complete presentation and final report

Timeline:



Timeline:

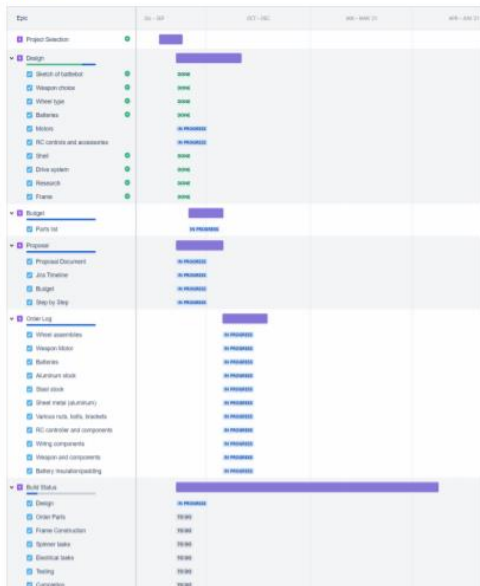

Cost:

Barricade Budget Breakdown					
Part	Price	Number of Parts	Price for parts needed	Estimated Shipped	Store
Spinner motor	109	x1	109	28	Robot Market Place
Wheel motor kit side A	260	x1	260	55	Robot Market Place
Wheel motor kit side B	260	x1	260	0	Robot Market Place
Batteries	70	x1	70	0	Amazon
Caster wheels	19	x1	19	0	Amazon
1/2" x 24" steel round stock	129.57	x1	129.57	45	onlinemetals.com
1/8" x 6" steel round stock	51.15	x1	51.15	0	McMaster
Sprocket 5/8" ID #25	12.67	x1	12.67	0	McMaster
Sprocket 1/2" ID #25	12.42	x1	12.42	60	McMaster
Chain #25 1/4" pitch 6'	30.84	x1	30.84	0	McMaster
Chain link connector	1	x2	2	0	McMaster
Bearings 1/8" ID	16.7	x2	33.4	13	Granger
Turnigy transmitter/receiver	56.19	x1	56.19	13	Hobby King
Receiver battery pack	8.28	x1	8.28	0	Amazon
Cable connectors	7.99	x1	7.99	0	Amazon
Remote on/off switch	8.24	x1	8.24	0	Hobby King
Electric speed control	46.99	x2	93.98	3	Horizon Hobby
On/off switches	7.65	x1	7.65	0	Amazon
10 gauge wire	15.48	x1	15.48	0	Amazon
12 gauge wire	9.95	x1	9.95	0	Amazon
Barrel connectors	18.99	x1	18.99	0	Amazon
Solder electrical and welding	40	x1	40	0	Amazon
7" x 1/8" bolt	1.25	x8	10	0	Lewis
Dowel pin 1/8" x 1" 5 count	12.79	x1	12.79	0	McMaster
1/8" lock washers 25 count	4.2	x1	4.2	0	Home Depot
1/8" washers 25 count	3.98	x1	3.98	0	Home Depot
1/8" nut 25 count	3.56	x1	3.56	0	Home Depot
1/8" x 3 1/2" lock 25 count	30.95	x1	30.95	0	Home Depot
48 x 5/2 in. self-tapping screws #260	7.21	x1	7.21	0	Home Depot
24" x 24" x 1/8" diamond plate	40	x1	40	20	Amazon
1/8" x 12" x 36" diamond plate	41.95	x2	83.9	0	Amazon
1/4" x 24" x 24" 6061 aluminum	88	x2	176	16	Yibay
paint decals	30	x1	30	0	Amazon
single metal (for brackets)	30	x1	30	0	Home Depot
1" x 1" x 1/2" Aluminum square stock	38.64	x1	38.64	34	Metals Depot
1/4" x 6" x 1/8" Aluminum 6061	14.2	x7	99.4	49	Amazon
Battery box insulation	25	x1	25	0	Amazon
Battery mounting components	20	x1	20	0	Amazon
Various other components and shipping	316	x1	316	0	Amazon
Total			52,164	538.00	
Total Estimate					\$2,100

Weight Analysis:

Material/Item	Weight (lb)	Comments
Aluminum 1/8"	93	1/4" side, back, and front panel, 1/4" top and bottom plate, battery box
Aluminum 1" x 1" bar	4	Bracing
Diamond plate 1/8"	17.5	Outside armor
Spinner	10	1" round bar stock steel milled, 1/8" steel bar
Spinner mounts	3.5	Mounts 1/8" ID
Spinner motor	6	Ampliflow E30-400 12V Motor 1.6hp
Spinner chain and sprockets	1.5	1/4" chain, sprocket ID 1/2", sprocket ID 1/8"
Wheel assemblies	17.5	Bartlett Single Drive Module A and B, E30 150 motor x2
Caster wheels	0.5	2 caster wheels
Batteries	25.5	Highly Max Battery 12V 13Ah F2 Rezer Battery W15128130023 3 Pack, 4 AA battery pack
Electrical components	1.5	Receiver, electrical speed control x2, remote on/off switch, wire, on/off switches, and connectors
Nuts, bolts, welds, brackets, etc.	15	Bolts, nuts, washers, screws, welds, motor brackets, spinner mount brackets
Total Estimate	158.5	Pounds

Note: This is a weight estimate. Weight will likely be slightly more due to armor bracing being installed on wheels!

Appendix:

Front:

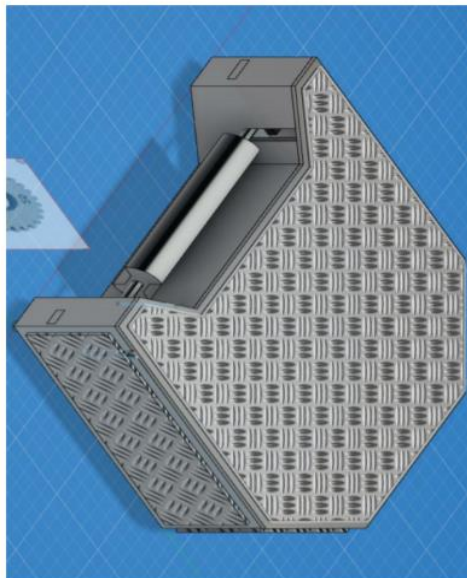

Final Comments:

The frame will be built with 1/4" aluminum, and the armor will be 1/8" aluminum diamond plate. The size of the bot being roughly 2' x 2' with a concave face. The 36 combined volts from the three 12-volt batteries for the spinner motor and the drive motors, is also well within the necessary range. The bot will have two wheels powered by two 12V motors and caster wheels. The weapon for this bot will be a custom milled spinner that will be powered by a 12V motor. The bot will be built mostly from aluminum to save weight.

Back:

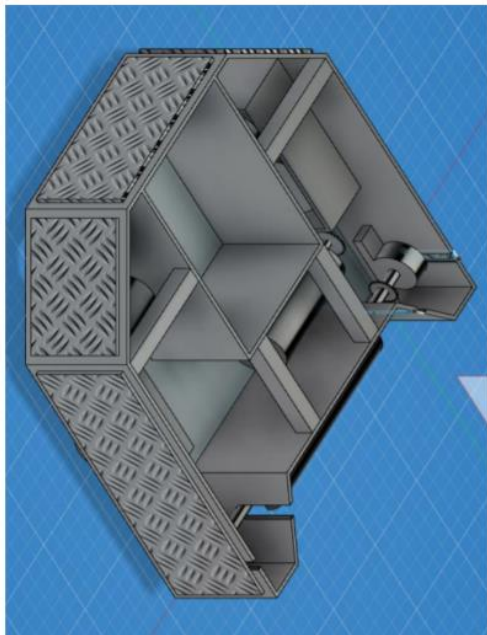

Dimensions:

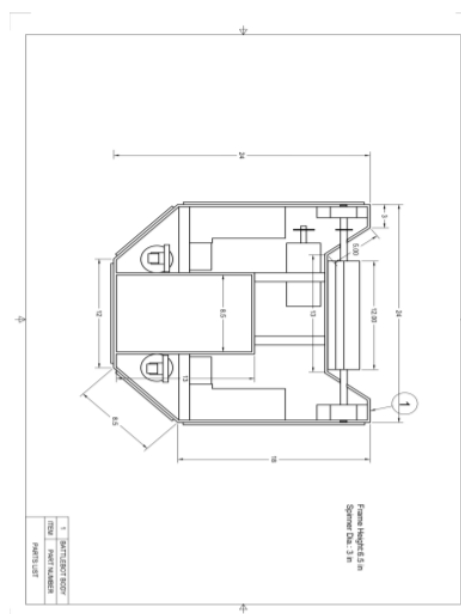

Weapon Motor:

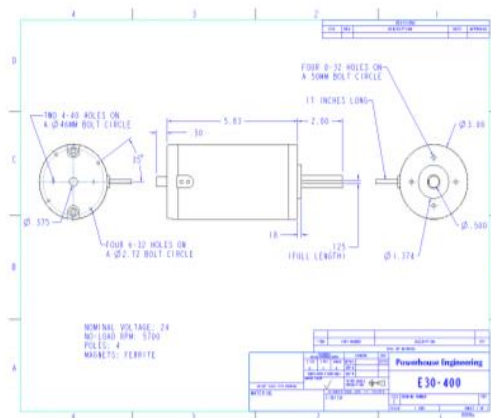

Electrical:

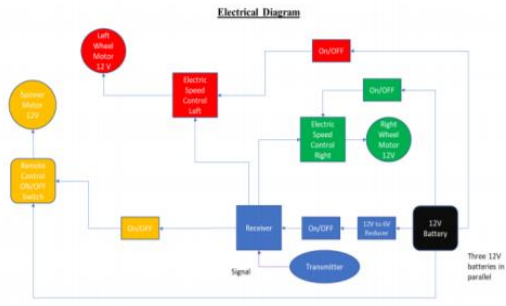

Wheel motors:

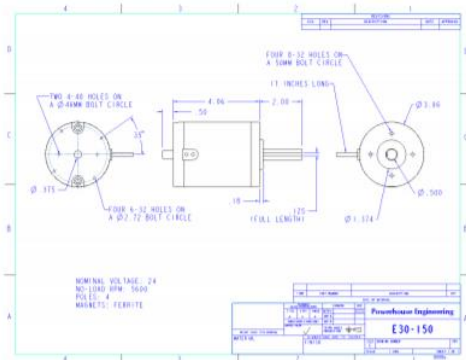

AmpFlow E30-150 12V Motor

<https://www.robotmarketplace.com/products/0-c30-150-12.html>

AmpFlow E30-400 12V Motor

<http://www.robotcombat.com/products/images/c30-400.GIF>

Final Presentation Slides:



Battlebot

ENT 498: Senior Design Project II Final Presentation

Team Members:

- Braden Bakenhaster
- Nick Newton

Advisor:

- Reza Abrisham Baf

Sponsored by: Armen Fleck



Agenda

- Introduction
- Problem Statement
- Why a Battlebot?
- Objective
- Expectations
- Design
- Proposal and Parts
- Construction
- Results
- Budget
- Gantt Chart
- Conclusions and Future Works
- References



Problem Statement

We need to design and create a project that incorporates Electrical and Mechanical aspects. This project should be creative and more importantly, this project should challenge our skills as engineers.



Why a Battlebot?

- A battlebot meets the requirements of the ENT 497 and 498 design class with both mechanical and electrical components.
- A battlebot provides a wide array of opportunities for design and building creativity. There are many different design options.
- The show *Battlebots* actually drew me (Braden) to the Electro-mechanical engineering field.



Objective

Objective:

We are going to construct a battlebot with a custom-built weapon mechanism that will be able to compete at a high level against other battlebots. The battlebot will follow the official rules of the Battlebots that are seen on the Discovery Channel.



Expectations

- Battlebot will have a spinning weapon mechanism
- Battlebot will be reasonably priced in terms of comparative battlebots
- Battlebot will meet necessary requirements provided by the official Battlebot rules
 - Under 8' x 8' in size [1]
 - Under 60 volts [1]
 - Under 250 pounds [1]
 - Having necessary manual power switches to meet requirements [1]
 - Rounds last 3 minutes, so our battlebot must last at least 5 minutes [1]



Design

• Research

- Types of battlebots
- Battlebot Rules [1]
- Materials used
 - Steel
 - Titanium
 - Aluminum
- Electrical systems
 - Motors
 - Batteries
 - ESCs
 - RC Systems



Design

Decisions Made from Research

- | | |
|---|--|
| <ul style="list-style-type: none"> • Type of battlebot <ul style="list-style-type: none"> • Spinner mechanism • Angles on rear • Spinner to sit in opening on the front of the bot • Materials <ul style="list-style-type: none"> • Aluminum: frame, bracing, armor, rear wheels mounts • Steel: spinner, spinner rod • Electrical <ul style="list-style-type: none"> • 12V system • ESCs for wheels | <ul style="list-style-type: none"> • RC on/off for spinner • 2.4Ghz controller with 6 channel receiver • Ampflo 12V 30-150 for wheels • Ampflo 12V 30-400 for spinner • Manual on/off switch for all power, wheels, and spinner |
|---|--|



Design

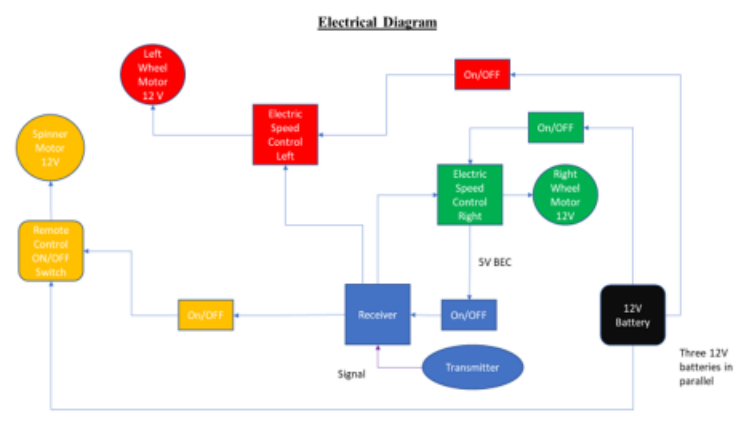

Proposal and Parts

- Proposal was written and approved
- Fleck scholarship awarded \$2500
- Parts list was created and sent in for order
 - Parts began being ordered on December 7th
 - Met January 13th to look over parts received that week
 - Construction of the battlebot began on Friday January 15th

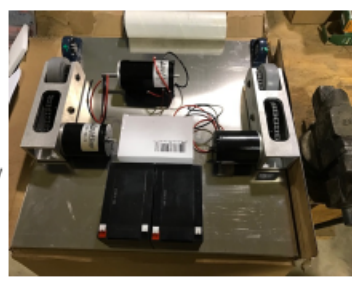

Construction

- Cut bottom plate to shape
 - Cut from 24" x 24" x 1/8" Aluminum
- Cut custom fit side pieces and welded together
 - Cut from 6" x 18" x 1/8" Aluminum
- Cut and welded the battery box into place
 - Cut from 6" x 18" x 1/8" Aluminum
- Mounted wheel assemblies
 - Drilled holes for mounting
 - Built shims
 - Mounted via bolts
- Mounted spinner mounts
 - Cut shims
 - Drills bolt holes in bottom
 - Drilled spinner holes in sidewall
 - Mounted via bolts



Construction (continued)

- Designed, built, and welded interior bracing
 - 1" x 1" x 1/8" Aluminum L
 - 1" x 1" Aluminum Bar
- Milled spinner and spinner motor mount
 - Custom milled spinner from 3" round steel
 - Custom milled steel bracket to fit Ampflo 30-400
- Mounted spinner
 - Attached steel rods to spinner using holes
 - Attached using mounts
- Mounted spinner motor with bolts
- Mounted Chain
 - Mounted Sprockets
 - Drilled chain holes
 - Built tensioner
- Mounted rear wheels
 - Built rear wheel mounts
 - Cut wheel hole in bottom plate



Construction (continued)

- Installed manual power switches
 - Mounted on custom built shelf
- Installed motor controllers
 - Wired in, mounted, and programmed
- Installed RC receiver
 - Mounted and programmed with controller
- Installed remote on/off switch for spinner
 - Switch was ineffective
 - Replaced with similar problem
 - Replaced with a 70-amp relay system
 - Manual on/off switches were upgraded
- Milled spinner again to remove weight
 - From 15 lbs to 12 lbs



Construction (continued)

- Installed new ESC for spinner
 - Relay system was upgrade to 80-amp ESC
- Paint
- Build battery mount
- Cut and installed armor
 - Cut from 1/8" Aluminum Diamond plate
 - Installed with bolts
- Cut and installed top plate
 - Cut from 24" x 24" x 1/4" Aluminum
- Swapped ESCs for wheels
 - ESCs upgraded to same as spinner
 - Better speed and performance
- Tests

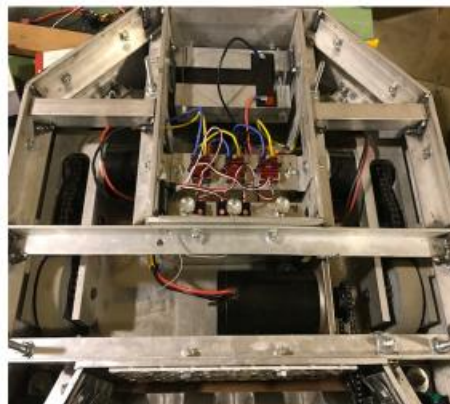

Results

Toolbot



Results

Voltage:

- Battery: 12 Volts
- BEC: 6 Volts

Weight:

- Total weight: 118lb
- Spinner only: 12lb

Battery Life:

- 6 minutes 54 seconds

Currents:

- Starting current of spinner: 18A

- Spinner Running current: 46A

- Spinner Max current: 59A

- Wheel Starting current 5A

- Wheel Running current: 8A

- Wheel Max current: 25A

Speeds:

- Speed of Battlebot: 7.7 MPH

- Speed of spinner: 8,000 Rpms

- Spinner Force: 1017 lb-ft

Results Demonstration Video



Budget

ENT 498		Advisor: Reza Abrisham Baf		Fleck Scholarship Funds	
Battlebot Budget					
Bradon Bakenhacker and Nicholas Newton					
Vendor	Date	Estimated Price	Price		2,500.00
Robot Marketplace check cc	12/1/2020	\$ 783.06	\$ 783.36	\$	1,711.64
ebay/paypal	12/7/2020	\$ 119.12	\$ 122.72	\$	1,588.92
hexTronik Limited/Paypal Hobby King	12/7/2020	\$ 68.99	\$ 68.99	\$	1,519.93
Granger	12/8/2020	\$ 44.38	\$ 58.64	\$	1,461.29
Momaster	1/5/2021	\$ 324.67	\$ 302.56	\$	1,158.73
Granger (Replaced Home Depot)	1/5/2021	\$ 49.06	\$ 32.75	\$	1,125.98
Amazon Replacement Motors	12/15/2020	\$ -	\$ 158.00	\$	967.98
Amazon	12/8/2020	\$ 500.55	\$ 407.96	\$	560.02
Robot Marketplace credit	x	\$ -	\$ (99.70)	\$	659.72
Metal Depot	x	\$ 64.07	\$ -	\$	659.72
Amazon	1/13/2021	\$ -	\$ 37.63	\$	622.09
Pololu	1/26/2021	\$ -	\$ 61.82	\$	560.27
*Autozone	3/26/2021	\$ -	\$ 33.96	\$	560.27
*Amazon	x	\$ -	\$ 358.53	\$	560.27
*Rural King	x	\$ -	\$ 155.28	\$	560.27
*Ebay	x	\$ -	\$ 29.18	\$	560.27
*Walmart	3/16/2021	\$ -	\$ 23.52	\$	560.27
Total			\$ 2,540.20		
Total Personal Cost			\$ 600.47		
Total Estimated Price ENT 497			\$ 2,500.00		
Total Fleck Order Estimate			\$ 1,954.50		
Total Fleck Used			\$ 1,939.79		
Total Over Estimate			\$ 40.20		

Gantt Chart

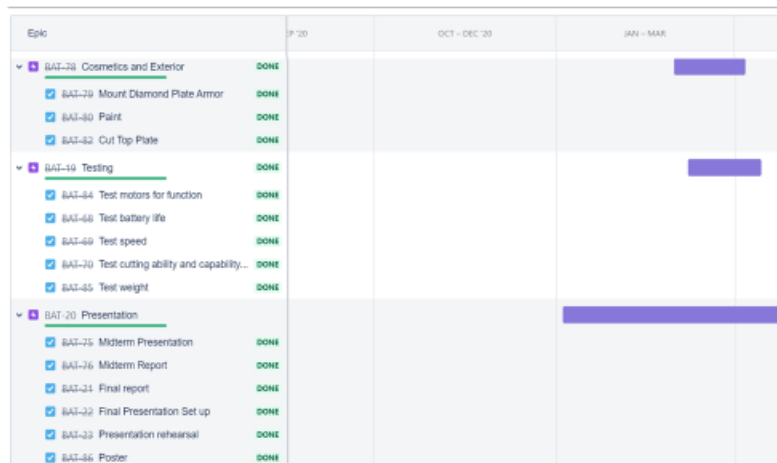

Conclusions and Future Works

Conclusion:

- Building this battlebot was an enjoyable learning experience
- It presented a very unique set of obstacles

Future Work Opportunities:

- Upgrade spinner
- Upgrade RC controller
- Upgrade battery
- Upgrade motors

References



[1] "BattleBots Tournament Rules 2020," *BattleBots*. [Online]. Available: <https://battlebots.com/rules/>. [Accessed: 27-Nov-2020].

A Special Thanks to:

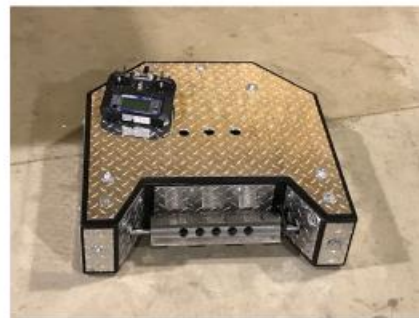
- Armen Fleck
- Reza Abrisham Baf
- Jeff Spriggs
- Miami University
- Shawnee State University



COLLEGE OF LIBERAL ARTS AND APPLIED SCIENCE
Department of Engineering Technology



Thank you for listening...

Braden Bakenhaster bakenhbj@miamioh.edu
Nicholas Newton newtonn@miamioh.edu

ENT 498: Senior Design Project II Final Presentation 4/30/2021

Presentation Link:

<https://youtu.be/M0O8saK2fgM>

Demonstration Video Links:

<https://youtu.be/e5hrZ7ICMlg>

<https://youtu.be/n59jIvzm1jQ>